



McIntosh Laboratory, Inc. 2 Chambers Street Binghamton, New York 13903-2699 Phone: 607-723-3512 www.mcintoshlabs.com

MCD12000

SACD/CD Player

Owner's Manual



The lightning flash with arrowhead, within an equilateral triangle, is intended to alert the user to the presence of uninsulated “dangerous voltage” within the product’s enclosure that may be of sufficient magnitude to constitute a risk of electric shock to persons.

WARNING - TO REDUCE RISK OF FIRE OR ELECTRICAL SHOCK, DO NOT EXPOSE THIS EQUIPMENT TO RAIN OR MOISTURE.

Additional Safety Information is supplied in a separate document “Important Additional Operation Information Guide”



ATTENTION:
RISQUE DE CHOC ELECTRIQUE - NE PAS OUVRIR

NO USER-SERVICEABLE PARTS INSIDE. REFER SERVICING TO QUALIFIED PERSONNEL.

The exclamation point within an equilateral triangle is intended to alert the user to the presence of important operating and maintenance (servicing) instructions in the literature accompanying the appliance.

To prevent the risk of electric shock, do not remove cover or back. No user-serviceable parts inside.

CAUTION: Invisible Laser Radiation when open. **DO NOT** stare into the beam or view directly with optical instruments. Use of controls or adjustments or performance of procedures other than those specified in the Owners Manual may result in Hazardous Radiation Exposure.

ATTENTION: Rayonnement Laser Invisible en cas d’ouverture. Ne pas regarder dans le faisceau ni observer directement à l’aide d’instruments d’optiques. L’utilisation de commandes, de réglages ou d’instructions autres que ceux spécifiés dans le manuel du propriétaire peut entraîner une exposition x à des rayonnements dangereux

This product incorporates an embedded **CLASS 3R Laser (IEC60825-1).**

**LUOKAN 1 LASERLAITE
KLASS 1 LASER APPARAT**

VAROITUS! Laitteen käyttäminen muulla kuin tassa käyttöohjeessa mainitulla tavalla saattaa altistaa käyttäjän turvallisuusluokan 1 ylittävälle näkymättömälle lasersäteilylle.

VARNING! Om apparaten används på annat sätt än i denna bruksanvisning specificerats, kan användaren utsättas för osynlig laserstrålning, som överskrider gränsen för laserklass 1.

CAUTION: CLASS 3R INVISIBLE LASER RADIATION WHEN OPEN. DO NOT STARE INTO THE BEAM OR VIEW DIRECTLY WITH OPTICAL INSTRUMENTS. AVOID DIRECT EYE EXPOSURE.
ATTENTION: RAYONNEMENT LASER INVISIBLE DE CLASSE 3R EN CAS D’OUVERTURE. NE PAS REGARDER DANS LE FAISCEAU NI OBSERVER DIRECTEMENT À L’AIDE D’INSTRUMENTS D’OPTIQUE. EXPOSITION DIRECTE DANGEREUSE DES YEUX.

**CLASS 1
LASER PRODUCT**

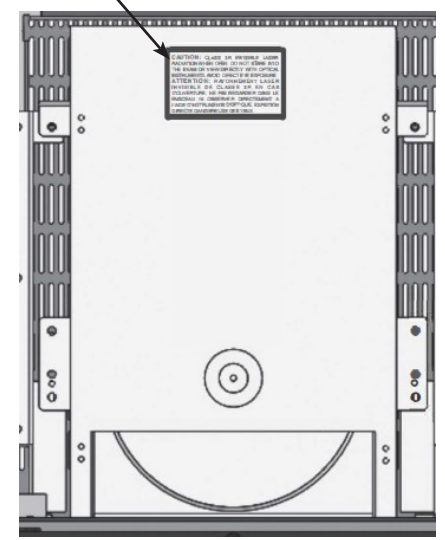
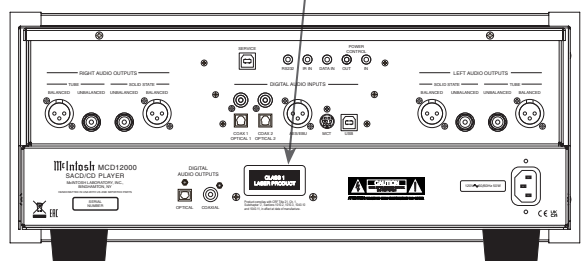

Interior view

Thank you from all of us at McIntosh

With the MCD12000 SACD/CD Player, you have invested in a precision instrument that will provide you with many years of enjoyment. Please take a few moments to familiarize yourself with the features and instructions to get the maximum performance from your equipment.

If you need further technical assistance, please contact your dealer who may be more familiar with your particular setup including other brands. You can also contact McIntosh with additional questions or in the unlikely event of needing service.

McIntosh Laboratory, Inc.
2 Chambers Street
Binghamton, New York 13903

Technical Assistance: (607) 723-3512
Customer Service: (607) 723-3515
Fax: (607) 724-0549
Email: support@mcintoshlabs.com
Website: mcintoshlabs.com

Make a Note

For future reference, you can jot down your serial number and purchase information here. We can identify your purchase from this information if the occasion should arise.

Serial Number:	
Purchase Date:	
Dealer Name	

Table of Contents

Introduction.....	3
Trademark and License Information	3
Dimensions	4
Where to Put It.....	4
Navigating the Rear Panel	5
Connection Diagram.....	6
Navigating the Front Panel.....	7
Navigating the Display.....	8
Connector and Cable Information	9
Using the Setup Menu.....	10
Playing/Navigating a Disc	11
Using Remote for MP3/WAV, Data Playback.....	12
Resetting the Microprocessor	13
Navigating the Remote Control	14
Changing Remote Control Batteries.....	15
Audio Specifications	18
Digital Audio Specifications.....	18
General Specifications.....	18
Packing the MCD12000.....	19

Introduction



The MCD12000 is McIntosh's flagship SACD/CD Player combining an award-winning history of vacuum tube innovation with cutting edge digital technology including the state-of-the-art professional series ESS Digital-to-Analog converter. The MCD12000 provides an unsurpassed sonic experience.

- Octal Balanced Low Distortion 32-bit PCM/DSD
- 8 DACs per channel
- Tube Balanced and Unbalanced Audio Outputs (as well as Solid State)
- 32Bit/384kHz Up-Sampling

- Advanced Transport with precision-Diecast Aluminum Drawer
- R-Core Power Transformer and Multi-Regulators Power Supply
- CD/DVD playability up to 24Bit/192kHz, DSD128

Trademark and License Information

The McIntosh MCD12000 incorporates copyright technology that is protected by U.S. patents and other intellectual property rights. The MCD12000 uses the following Technologies:

Trademark	License Information
	ASIO is a trademark and software of Steinberg Media Technologies GmbH
	Manufactured under license from Dolby Laboratories. Dolby, Dolby Audio, and the double-D symbol are trademarks of Dolby Laboratories.
	For DTS patents, see http://patents.dts.com . Manufactured under license from DTS, Inc. DTS, the Symbol, DTS and the Symbol together, and Digital Surround are registered trademarks and/or trademarks of DTS, Inc. in the United States and/or other countries. DTS, Inc. All Rights Reserved.



Dimensions

Front View

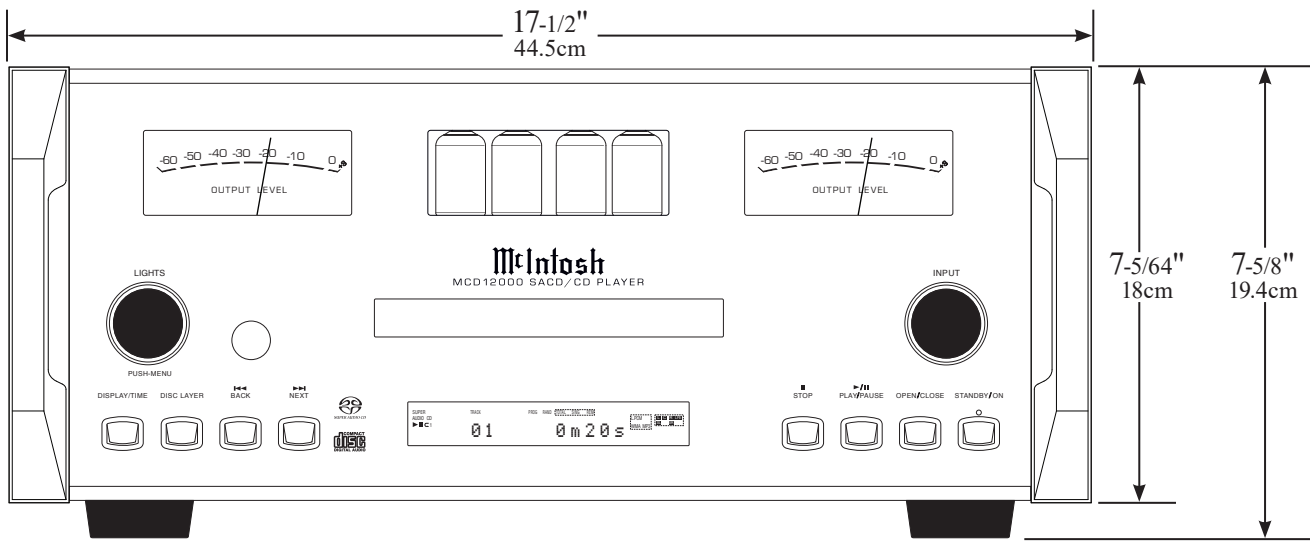

Rear View

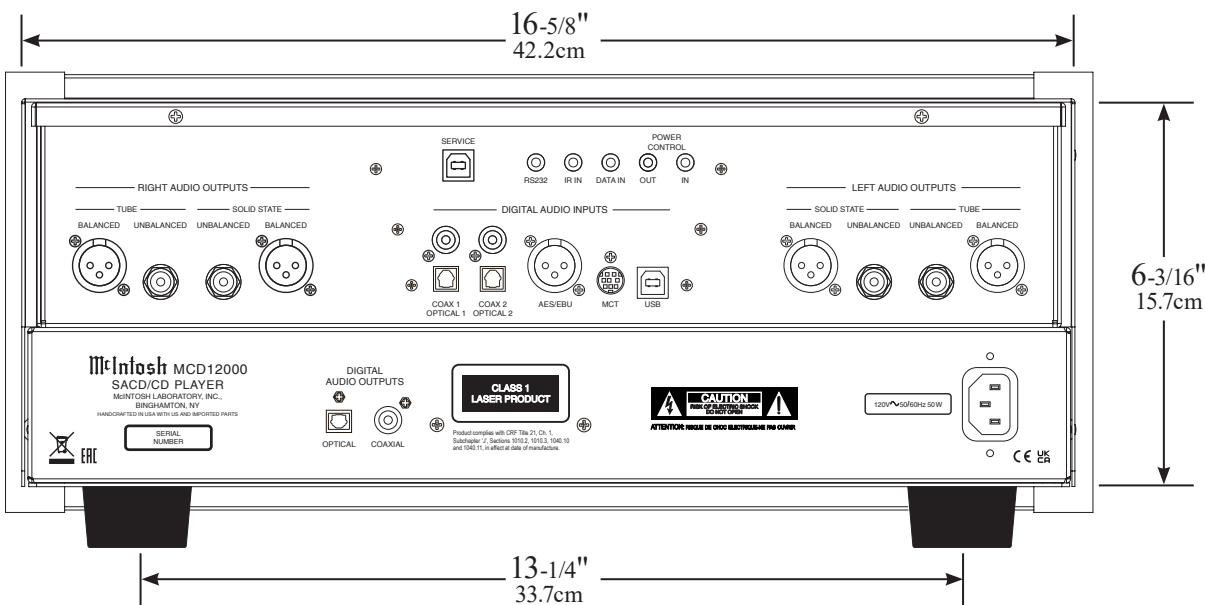

Where to Put It

The MCD12000 can be placed upright on a table or shelf, standing on its four feet. It also can be custom installed in a piece of furniture or cabinet.

Always provide adequate ventilation for your MCD12000. Cool operation ensures the longest possible operating life for any electronic instrument. Do not install the MCD12000 directly above a heat generating component such as a high-powered amplifier. If all the components are installed in a single cabinet, a quiet running ventilation fan can be a definite asset in maintaining all the system components at the coolest possible operating temperature.

A custom cabinet installation should provide the following minimum spacing dimensions for cool operation:

- 6 inches (15.3cm) above the top
- 5/8 inches (1.6cm) below the bottom
- 2 inches (5.1cm) on each side of the MCD12000 so that airflow is not obstructed
- 18 inches (45.7cm) depth behind the front panel
- 2 inches (5.1cm) in front for handle clearance

Side View

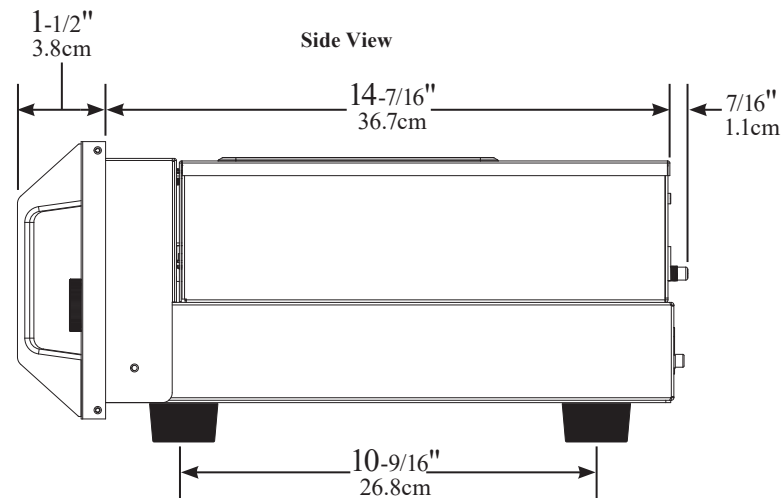

Navigating the Rear Panel

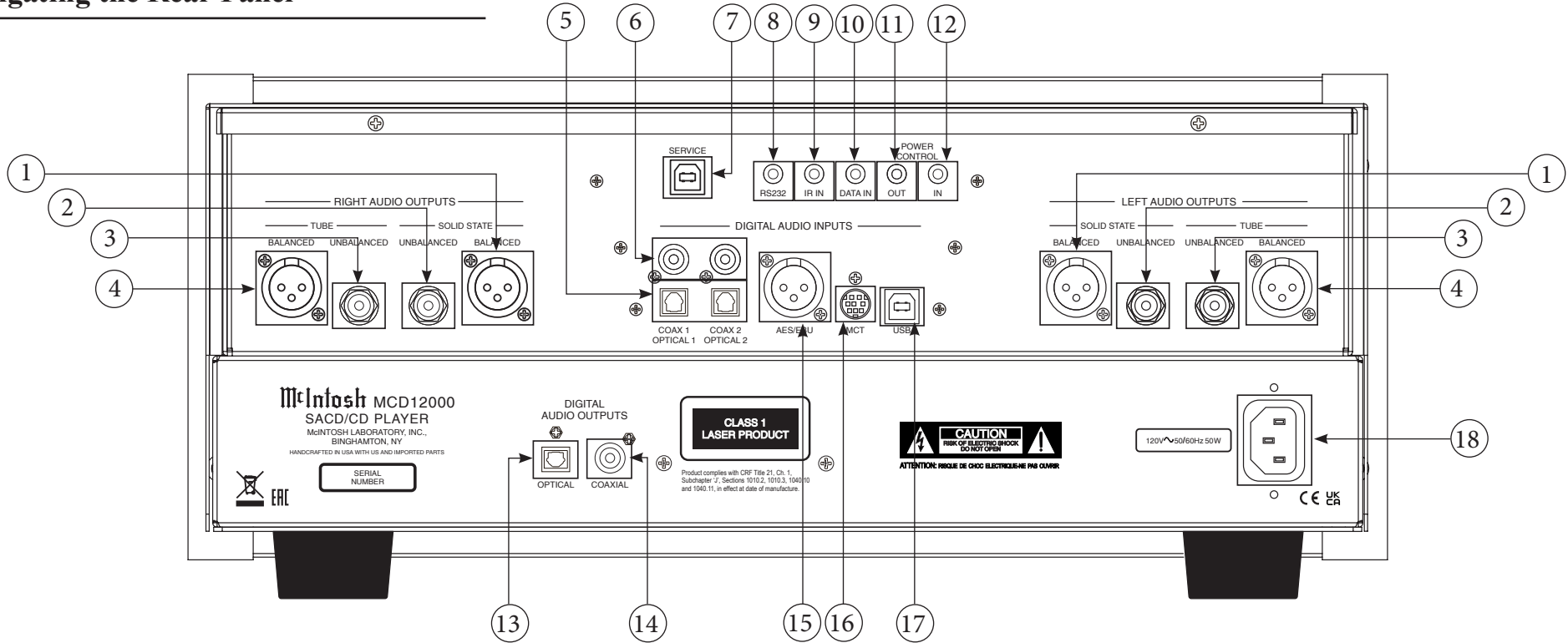

- 1. Balanced Outputs (Solid State):** These ports produce Solid State signals using XLR connector cables.
- 2. Unbalanced Outputs (Solid State):** These ports produce Solid State signals using RCA connector cables.
- 3. Unbalanced Outputs (Tube):** These ports produce Tube signals using RCA connector cables.
- 4. Balanced Outputs (Tube):** These ports produce Tube signals using XLR connector cables.
- 5. Optical Inputs:** These ports accept optical connections for digital signals.
- 6. Coax Inputs:** Connect coaxial cables for digital signals into these ports.

- 7. Service Port:** This USB Type-B port will be used for service purposes only.
- 8. RS232 Port:** Using a 3.5mm-to-DB9 cable, you can connect the device to a computer or another controller device through here.
- 9. IR In Port:** Connect an external IR sensor here with a 3.5mm connector.
- 10. Data In:** Using a 3.5mm data cable, this port receives control data from a McIntosh Integrated Amplifier or Preamplifier.
- 11. Power Control Out:** Sends an On/Off signal to a connected McIntosh component via a 3.5mm cable.
- 12. Power Control In:** Receives an On/Off signal from a connected McIntosh component via a 3.5mm cable.

- 13. Optical Output:** Connect an optical cable to transmit a digital signal from this port via the DISC input.
- 14. Coax Output:** Connect a coaxial cable to transmit a digital signal from this port via the DISC input.
- 15. AES/EBU:** This port accepts a balanced digital signal.
- 16. MCT Input:** Used to transfer signals from McIntosh products with an MCT connector.
- 17. USB Audio Input:** A USB Type-B connector will go here to receive a digital signal from a computer.
- 18. Main Power:** Connect to a power outlet using the included power cable to supply power to the MCD12000.



Connection Diagram

Here are some common connections for the MCD12000:

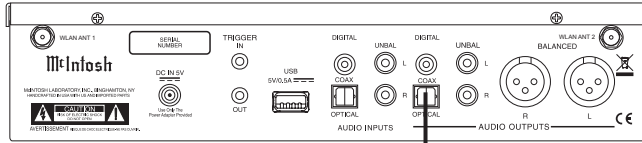

Output can be sent via Balanced or Unbalanced cables (Right Balanced Tube)

Digital signals can be sent to Optical or COAX Inputs

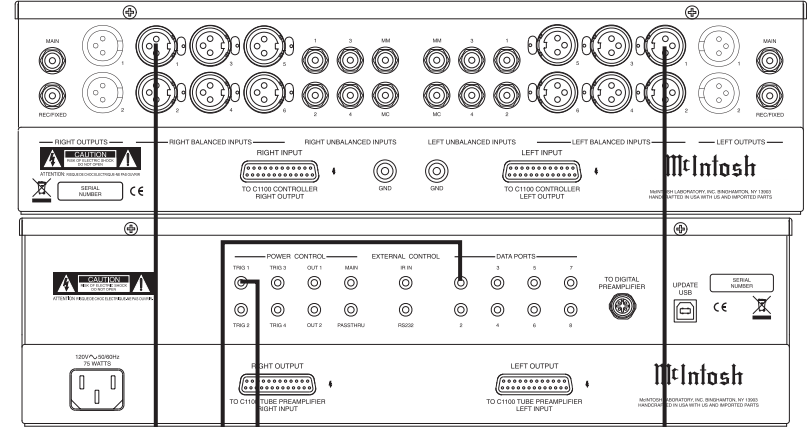

Connect a Power Control (Trigger) cable from Preamp to Power Control IN

Output can be sent via Balanced or Unbalanced cables (Right Balanced Tube)

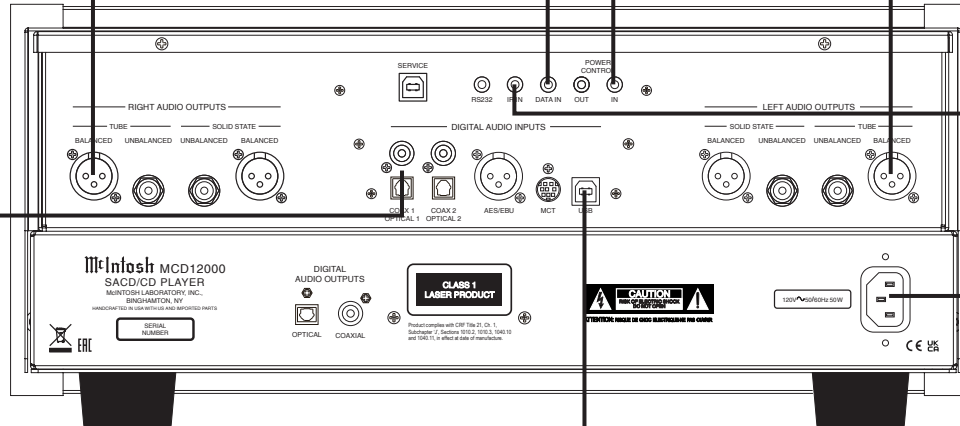

IR Sensor

Connect to AC Power Outlet



USB Cable to Computer

Navigating the Front Panel

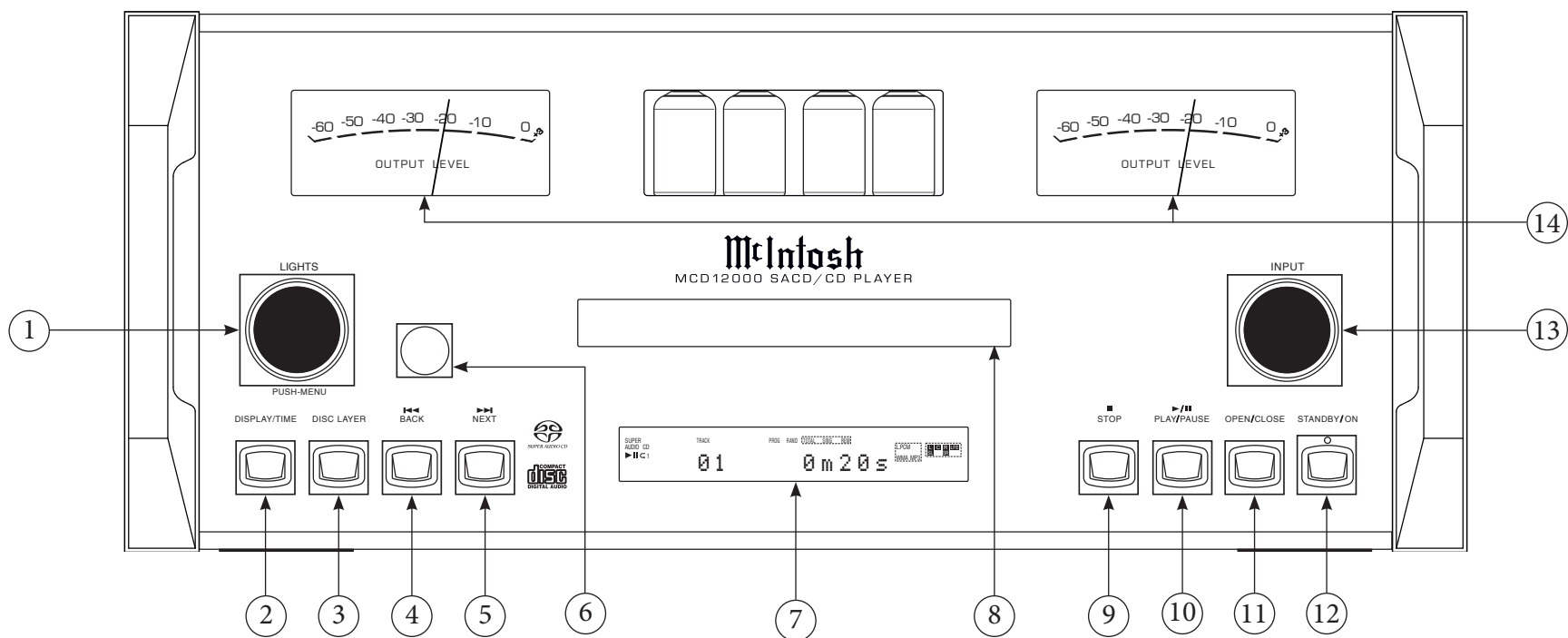

1. Lights/ Push-Menu Knob: This knob controls the Meter and Tube lights (On/Off). It also allows you to enter the Setup Menu by pushing it. Rotating the knob while in the Setup Menu allows you to navigate through the menu options.

2. Display/Time Button: Cycles between showing on the display the Total Remaining Time, Single Track Remaining Time, or Track Time.

3. Disc Layer Button: Toggles between CD, STEREO (SACD), and MULTI (SACD) playback.

4. Back Button: Play previous track.

5. Next Button: Play next track.

6. Infrared Sensor: This is how the MCD12000 receives commands from your Remote Control.

7. Vacuum Fluorescent Display (VFD): Displays Menu and playback information.

8. Disc Tray: Where you insert your CDs.

9. Stop Button: Cancels media playback and resets progress through it.

10. Play/Pause Button: Halts playback of active media and will resume from where it left off if you press the button again.

11. Open/Close Button: Opens and closes the Disc Tray.

12. Standby/On Button: Turns MCD12000 On/Off. When the MCD12000 unit is in Standby (turned Off), the LED above the button will be green if Auto-Off is enabled, or red if Auto-Off is disabled (see Page 10).

13. Input Knob: Rotate this to select different Input sources for playback.

14. Output Level Meters: Indicates the signal level being delivered from the Outputs.



Navigating the Display

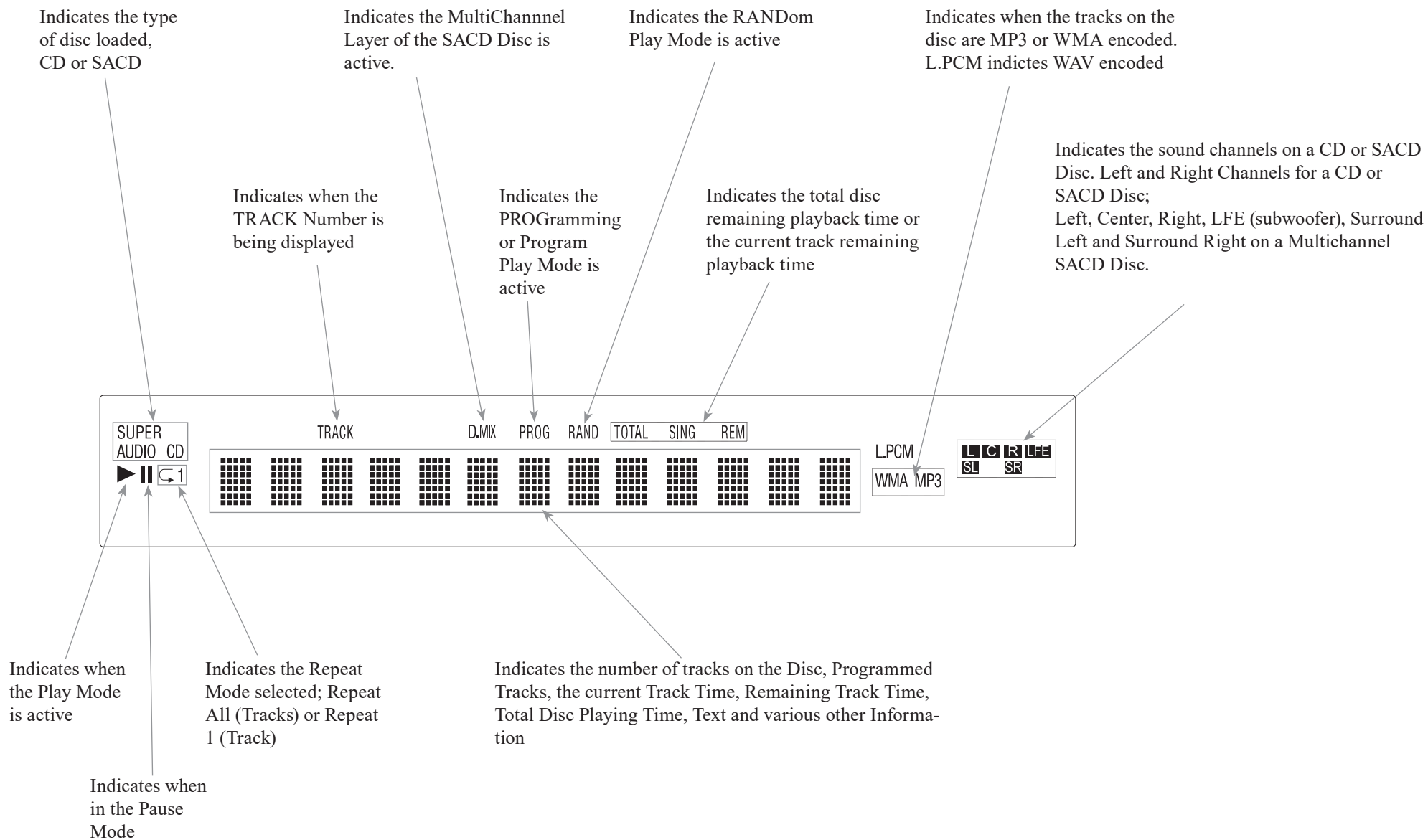

Connector and Cable Information

XLR Connectors

Below is the Pin configuration for the XLR Balanced Outputs and Digital (AES/EBU) Input Connectors on the MCD12000. Refer to the diagram for connection:

- PIN 1: Shield/Ground
- PIN 2: + Output/+ Signal
- PIN 3: - Output/- Signal

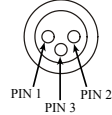

Power Control Trigger Connectors

The Power Control Trigger Output Jack sends while the Power Control Trigger Input Jack receives Power On/Off Signals (+12 volt/0 volt) when connected to other McIntosh Components. An additional connection is for controlling the level of the Output Meters on McIntosh Power Amplifiers, as well as the built-in Output Level Meters. A 3.5mm stereo mini phone plug is used for this connection.

Main, Trig 1&2 and Pass-Thru

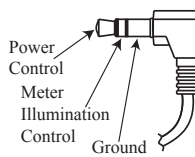

Data Port Connectors

The Data In Port receives Remote Control Signals from a Source Component. A 3.5mm stereo mini phone plug is used for connection.

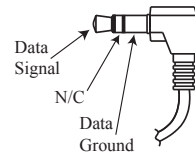

IR IN Port Connectors

The IR IN Port also uses a 3.5mm stereo mini phone plug and allows the connection of other brand IR Receivers to the MCD12000.

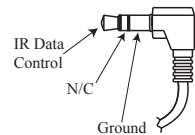

RS232 Port Connector

The RS232 Port uses a 3.5mm stereo mini phone plug to connect to external third-party controllers.

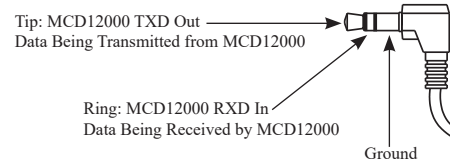

USB Audio

The USB AUDIO input of the MCD12000 provides the capability to receive music/sound in a digital format from a connected computer.

Software Requirements

Apple® Macintosh® computers require OS-10.6.8 or later. Apple computers require no additional driver install to communicate with the MCD12000.

For Windows-based computers (PC), Windows 7 (SP1) or later is required. The correct McIntosh USB Audio driver must be installed for the PC to communicate with the MCD12000.

To **install the McIntosh USB Driver** for Windows-based computers:

Download the latest driver from the McIntosh website: <https://www.mcintoshlabs.com/products/cd-players/MCD12000>

The driver can be found in the Downloads section of the webpage under Software Updates.

- Unzip the McIntosh_UsbAudio file
- Run the File
- Choose “Yes” to allow changes to your computer
- Follow software prompts selecting “Next” or “Install” as needed
- Click “Finish” when driver is installed

Next, connect the Computer to the MCD12000 using a **USB 2.0** Cable Type A to Type B.

Windows should detect the new device (if you installed the driver software as directed above) and install the driver as indicated by a message in the lower part of your monitor.

You can use the Windows Control Panel to select the new audio device which will appear as “McIntosh HD-HS 2 [ASIO] USB Audio”. You may also select this driver in many third-party applications such as JRiver Media Center.

The MCD12000’s display will show the sampling rate or bit rate for the USB input.

USB Service Port

The USB SERVICE PORT on the rear of the MCD12000 is for McIntosh service use only. Use the USB AUDIO port for audio input.

MCT

The Digital MCT Input directly decodes SACD/CD signals from an external Transport component. The MCT Input uses a McIntosh designed custom cable, part number 171923. This cable is only supplied with McIntosh MCT Transport products.

Optical

The two Optical Inputs allow digital sources to be connected to the MCD12000 using TOSLINK cables also known as “optical audio cables.”

Coax

The two Digital Coax (Coaxial) Inputs allow digital sources to be connected to the MCD12000 using Digital Audio RCA Coaxial Cables.



Powering on the MCD12000

To power on the MCD12000, press Standby/On Button. To power the MCD12000 off, do this again.

Using the Setup Menu

To enter the Setup Menu, push and release the Left Knob. Turning the Left Knob will scroll through the available options.

The following is a table listing the Setup Menu's different Settings options and their available configurations:

Setting	Options
MCD12000	Displays current firmware version
S/N AJDxxxx	Displays the serial number of the MCD12000
DI FW Vx.x	Displays the current firmware for the digital interface module
Auto-Off	ON (default) / OFF
IR Code	Norm (default) / Alt
Front IR	ON (default) / OFF
Power IR	ON (default) / OFF
IR Input	ON (default) / OFF
Inputs (HOLD) <i>Hold Left Knob to enter submenu</i>	Submenu Choices: COAX 1, COAX 2, OPT 1, OPT 2, USB, MCT, AES/EBU Options for each: ON (default) / OFF
BAUD	115200 (default), 9600, 19200, 38400, 57600
Factory Reset	Press and hold Left Knob to perform Factory Reset

Firmware Version

Firmware is internal software that controls the MCD12000's functionality.

The version of the main firmware of the MCD12000 can be viewed by entering the Setup Menu. Enter this by pressing and releasing the Left Knob. The first setting is called MCD12000. The number to the right is the version number. For example, if the VFD displays "MCD12000 V1.01", then the main firmware is version 1.01.

There is also firmware for controlling the digital audio hardware. To see the Digital Input (DI) firmware version, enter the Setup Menu. Rotate the Left Knob until you see "DI FW". The number following the V to the right is the Digital Input firmware version.

Firmware upgrades when available can be installed by qualified technicians.

Serial Number

The MCD12000's unique serial number can be viewed by entering the Setup Menu and rotating the Left Knob until you see "S/N:". The number (and letters) to the Right are the unit's serial number. This number can also be found on the rear of the unit.

Auto-Off

Auto-Off can be toggled On (default) or Off. Enter the Setup Menu. Select On or Off by rotating the Right Knob.

When enabled, the Auto-Off feature powers off the MCD12000 when no audio input or user interaction has been detected for approximately 30 minutes.

When the MCD12000 unit is in Standby (turned Off), the LED above the button will be green if Auto-Off is enabled, or red if Auto-Off is disabled.

If the Power Control In port on the MCD12000 is connected to a source component, the Auto-Off feature will be disabled automatically.

IR Code

The IR Code setting allows you to select an alternative set of remote control codes to use for the remote control of the MCD12000. The default is to use the Normal control codes which will be perfectly fine for the vast majority of situations. If you have another unit being controlled with the same control codes, conflicts can arise. If this is the case, change IR Code setting to "Alt". The remote control for the MCD12000 must also be set to use the alternate codes.

To set the MCD12000's remote control to use alternate (Alt) codes, press and hold the SELECT button and press the "2" button. Hold until the two LEDs to the right of the SHIFT button flash twice.

To set the MCD12000's remote control to use normal codes, press and hold the SELECT button and press the "1" button. Hold until the two LEDs to the right of the SHIFT button flash twice.

Front IR

Front Panel Sensor, which receives the signals from the Remote Control, can be switched off to prevent interference when an external IR Sensor is connected. To de-activate the Front IR, enter the Setup Menu. Select On or Off by rotating the Right Knob.

Power IR and IR Input

The MCD12000 can be controlled by another McIntosh unit's remote control using the DATA IN PORT. This is convenient for using commands on the other remote such as PLAY or NEXT, but it is possible that you may not want Power commands or Input commands sent by the connected unit to control the MCD12000.

If you wish to disable Power Commands coming from the DATA PORT or from a connected external IR sensor connected the IR IN, enter the Setup Menu. Select On or Off by rotating the Right Knob.

Note: When AC Power is initially applied to the MCD12000, the unit will momentarily switch On and then go into the Standby Mode.

Input Setup

You have the ability to control which inputs appear on the display when you rotate the Input (Right) Knob. If you wish to remove an unused input or restore a previously removed input:

- Push and release the Left Knob to enter Setup
- Rotate the Left Knob until the VFD displays “Inputs (Hold)”
- Press and Hold the Left Knob for two seconds. “CD PLAYER” will appear in the VFD
- Rotate the Left Knob to select the input you wish to display or hide
- Rotate the Right Knob to select On or Off
- Press and release the Left Knob twice to exit the Setup Menu

Baud Rate Setup

The MCD12000 can be controlled remotely via the RS232 Jack. The settings for serial communications are:

- 8 bit, No parity and 1 stop bit

The speed can be adjusted from the Setup Menu.

To adjust the BAUD rate, enter the Setup Menu. Rotate the Left Knob until you reach “BAUD: ...” Rotate the Right Knob to select from the following options:

- 9600, 19200, 38400, 57600, and 115200 (default).

Factory Reset

Use the FACTORY RESET option if you wish to return all settings to factory defaults. All previous setup changes will be lost.

To Factory reset the MCD12000, enter the Setup Menu. Rotate the Left Knob until “FACTORY RESET” appears on the display. Hold the Left Knob down until “In Progress” appears on the screen. When the Factory reset is complete, the MCD12000 will power off.

Playing/Navigating a Disc

- Rotate the Right Knob (INPUT) until CD PLAYER appears on the Display
- Press and release the OPEN/CLOSE button to open the tray
- Place the disc, label side up, on the tray
- Press and release the OPEN/CLOSE button to close the tray
- “Reading” will appear on the Display followed by Disc information
- You may press the BACK and NEXT buttons to pick a particular track
- Press and release the PLAY/PAUSE button to Play; press again to Pause

Additional commands are available on the Remote Control. See “Navigating the Remote Control” on Page 14.

The **Program Playback** feature allows the playback of selected tracks in a chosen order. To use this feature, Press the SHIFT button on the Remote Control and then press the RANDOM button twice. Use the numeric buttons to enter the desired tracks. Press the PLAY button to begin playing the programmed tracks.

Navigating CD-ROMs

The Remote Control buttons 2, 4, 6 and 8 can be used for navigating up, down, left, right through tracks/folders on a CD-ROM. The 5 button can be used to Enter the folder or Play the track shown on the Display. For navigating data discs, please see Page 12.



Using Remote for MP3/WAV, Data Playback

Load a DATA (CD or DVD) or MP3/WAV Disc into the MCD12000. The MCD12000 has different Operational Playback Modes when a Disc contains DATA music files. The Operational Mode Selection includes the “All Mode” and the “Folder Mode”, which are indicated by the Front Panel Display.

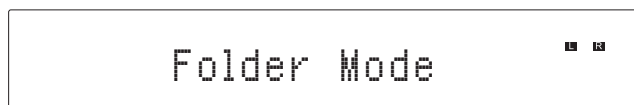
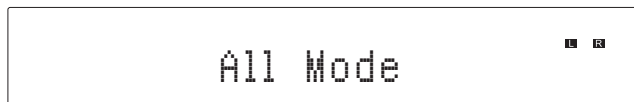

To check the current Operation Mode, press the MODE button on the Remote Control once. To change the current Operation Mode, press the MODE button twice, followed by pressing the PLAY button to activate the selected Operation Mode.

When conventional CD or SACD DISCs are played, all the sound tracks are sequentially numbered and are played back in that numeric order. This standard playback mode is referred to as the “All Mode” of operation.

CD Data, DVD Data, and MP3/WAV Discs are usually created on a computer, which can create multiple folders that are in a sequential order. Each folder can contain multiple sound tracks that are in a sequential order. This playback mode is referred to as the “Folder Mode” of operation. Refer to “Front Panel Display” for an example of the Front Panel Indications of the Folder Mode content.

Front Panel Display

When playing a Data CD Disc or Data DVD Disc, the MCD12000 Front Panel Information Display will also indicate the following:

- Folder or Sub-Folder Name - Music One
- Artist Name - Freddie King
- Album Name - Getting Ready
- Track Name - 09 Tore Down
- Audio Format Type and Sampling Frequency - WAV 44.1kHz

Upper and Lower Symbol

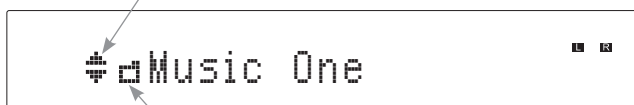

Folder Symbol



Music Symbol

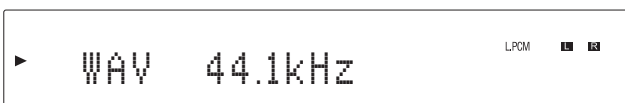
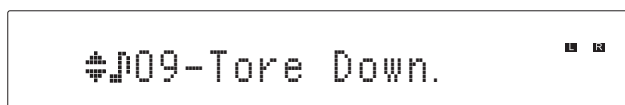
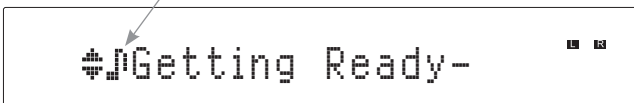

After the Folder Mode has been selected, the Front Panel Information Display will indicate the Folders, Sub Folders, and Tracks. It also indicates the Album Name, the Artist Name, the Track Name, and the Track Time, along with the Audio Format Type and Sampling Frequency. Due to the operational differences of various computers and the MCD12000, sequel listing of the Folders, Sub Folders and Tracks will usually be different. If the All Mode on the MCD12000 was selected, the sequential listing will also be different.

Display Brightness

There are three available Settings for the Front Panel Display. The choices include brightness settings of high (default setting), medium or low. To change the brightness setting perform the following steps:

1. Select CD Player/ DISC Input
2. Press the SHIFT Push-button.
3. Momentarily press the 2 (DIM) button to change the current brightness setting. Repeat this until the desired brightness setting is selected.

Starting Playback

1. Use the INPUT Control or INPUT button on the Remote Control to select DISC/CD Player.
2. Using the Remote Control, press the Number 5 button to start playback.
3. If the desired track for playback is located in a different folder, press the Number 4 button first. Then, use the Number 2 (select the Upper ▲ Data Folder) or Number 8 (select the Lower ▼ Data Folder) button to select the desired folder. Select the desired Track using the Number 2 or Number 8 button. Once the Desired Track Name is indicated on the Front Panel Information Display, press the Number 5 button to start playback of the track.

Note: Once the desired folder has been selected, the Remote Control NEXT button can be used to select the desired track. Then, the Remote Control PLAY Pushbutton when pushed will start playback of the track.

4. While the track just selected is playing back, the Front Panel Display may also indicate the Track Name, followed by the Artist Name and/or the Album Name by pressing the MENU/TEXT button several times.
5. Press the DISPLAY/TIME button (once or twice) to indicate on the Front Panel Display the Audio Format Type and Sampling Frequency of the track that is playing back.

Selection of a Different Sub Folder

1. Press the Number 4 button. The Front Panel Display will indicate the name of the current folder.
2. Press the Number 2 button to select an Upper▲ Data Folder or press the Number 8 button to select a Lower▼ Data Folder. Once the desired folder has been selected, push the Number 6 button once to identify the first track in the folder. Press the Number 6 button to start playing the first track from the selected folder, or press the Number 6 button a second time to start playing the second track.
3. Press the MENU/TEXT button to display the Artist Name, followed by the Album Name, and then the Track Name and Number.
4. Press the DISPLAY/TIME button to display the track number display time. Press the DISPLAY/TIME Push-button a second time to display the Audio Format Type and the Sampling Frequency.

Resetting the Microprocessor

In the unlikely event the MCD12000 stops functioning properly and the Factory Reset procedure (see “FACTORY RESET” on Page 11) does not solve the issue, you can try the following procedure to reset the secondary (transport) microprocessor:

- Power off the MCD12000
- Remove the AC power cord from the rear of the MCD12000
- Wait a few seconds for the standby LED to turn off
- Push and Hold the NEXT button in while pressing and holding the STOP button
- Plug the AC power cord into the rear of the MCD12000
- When “INITIALIZED” appears on the Display, release the NEXT button and STOP button

The MCD12000 should be reset in a few more seconds.



Navigating the Remote Control

SHIFT push-button with LED Indicators used to select a push-button function with white or gold color nomenclature

Use to CLEAR the last programmed track

Access the TEXT Display Mode when playing a SACD Disc containing the information

Use to select various disc information, including TIME, on the Front Panel DISPLAY. It is also used to cancel the text display mode on a SACD Disc

Use to select the SACD or CD Tracks from a hybrid disc for playback

Press to play the Previous Selection. Also used to select one of various REPEAT modes

Press once to PLAY, a second time to PAUSE and a third time to RESUME playback. Also used to activate RANDOM playback of the tracks on a SACD or CD disc

Press to FAST-REVERSE thru the current selection

Press to toggle Meter or Tube Lights ON or OFF

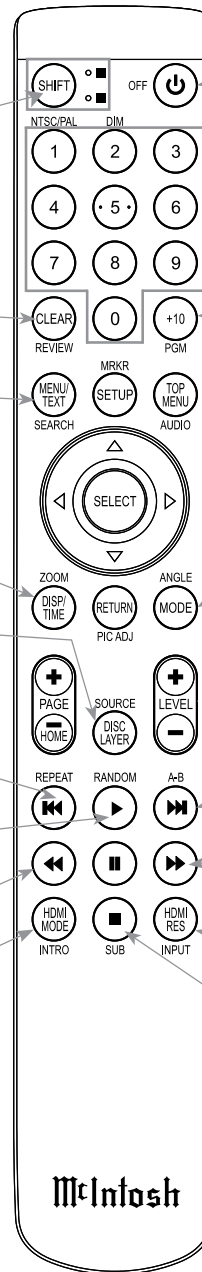

Momentarily press to Power ON or OFF

Use to select disc tracks or any numbered operation

Use to direct access tracks 10 and above

Selects the All MODE or the Folder MODE for navigating and selection of music on a CD-R or DVD ±R

Press to play the next Selection

Press to FAST-FORWARD thru the current selection

Select Disc, USB Mode or Coax/Optical Digital Inputs

Press to STOP disc playback

Note: The Remote Control Push-buttons not identified are for use with other McIntosh Products

Note: If at any time the Player seems unresponsive to the desired Remote Control Command, it may be necessary to select the color of the push-button nomenclature for the desired command. This is accomplished by first pressing the SHIFT Push-button to select gold, as indicated by the LED, and then within 3 seconds pressing (or in the case of some functions repeatedly pressing) the desired command push-button.

Changing Remote Control Batteries

Someday, the two AAA battery in the Remote Control will need to be replaced. To replace the two AAA batteries:

- Locate the battery door. Looking at the back of the remote, the battery door is in the lower part
- Slide battery door towards the bottom of the Remote Control. The battery door will slide open 1/4 inch (0.63cm)
- Lift the door up to reveal the batteries
- Remove the old batteries
- Insert two new AAA batteries noting the polarity which is printed on the bottom of the battery compartment. The spring will connect with the negative (-) part of the battery
- Place the door over the batteries leaving a 1/4 inch gap
- Slide the door up towards the top of the remote to secure







Audio Specifications

Disc Formats

CD, SACD, CD-R, CD-RW, and DVD (DATA)

Fixed Output level

2.0Vrms Unbalanced

4.0Vrms Balanced

Output Impedance

600 ohms Unbalanced and Balanced

Frequency Response

4Hz to 20,000Hz, ±0.5dB (CD)

4Hz to 40,000Hz, +0.5, -2dB (SACD)

Signal to Noise Ratio

110dB (A-weighted)

Dynamic Range

Better than 100dB

Harmonic Distortion

0.003% @ 1,000Hz

Channel Separation

Better than 98dB (1,000Hz)

Playable Disc Media Files

Format	Up To Frequency/ Bit	Bit Rate
MP3 (.mp3)	48kHz	up to 320kbps
WMA (.wma)	48kHz	up to 320kbps
AAC (.aac/ mp4)	48kHz	up to 320kbps
WAV (.wav)	192kHz/24 Bit*	uncompressed
FLAC (.flac)	192kHz/24 Bit*	uncompressed
ALAC (.m4a)	96kHz/24 Bit*	uncompressed
AIFF (.aif/aiff)	192kHz/24 Bit*	uncompressed
DSD (.dff/dsf)	DSD128 (5.6MHz)	uncompressed

*up to 48kHz with CD-R/+RW

Digital Audio Specifications

Digital Input Format

SPDIF (PCM¹)

Digital Inputs

Coaxial: 0.5V p-p/75 ohms

Optical: - 15dbm to -21dbm (TOS Link)

MCT: 0.5V p-p/75 ohms

USB: USB 2.0 Type B Connector

Digital Input Sample Rate

Coaxial: 16, 24-Bit/192kHz, Dolby Digital, DTS

Optical: 16, 24-Bit/192kHz, Dolby Digital, DTS

MCT: SACD, PCM: 16, 24-Bit/44.1kHz to 192kHz

USB: PCM: 16, 24, 32-Bit/44.1kHz to 384kHz

DXD: DXD352.8kHz, DXD384kHz

DSD: DSD64, DSD128, DSD256, DSD512

Digital Audio Output Format

Coaxial and Optical: SPDIF (PCM¹), IEC958

44.1kHz to 192kHz/24Bit

Digital Outputs

Coaxial: 0.5V p-p/75 ohms

Optical: - 15dbm to -21dbm (TOS Link)

Digital Output Sample Rate

Up to 24-Bit/192kHz for DISC Input only

¹ PCM (Pulse Code Modulation) Digital Signal type used for CD Discs

General Specifications

Transport

Laser Type: Twin Beam

Laser Beam Wavelength: 650nm (SACD)/790nm (CD)

Laser Power: CLASS IIa/CLASS I

Power Requirements

100 Volts, 50/60Hz at 50 watts

110 Volts, 50/60Hz at 50 watts

120 Volts, 50/60Hz at 50 watts

127 Volts, 50/60Hz at 50 watts

220 Volts, 50/60Hz at 50 watts

230 Volts, 50/60Hz at 50 watts

240 Volts, 50/60Hz at 50 watts

Standby: Less than 0.5 watt

Note: Refer to the rear panel of the MCD12000 for the correct voltage.

Overall Dimensions

Width is 17-1/2 inches (44.4cm)

Height is 7-5/8 inches (19.4cm)

Depth is 19 inches (48.3cm) including the Front Panel Handles and Cables

Note: When the Disc Tray is opened, the panel clearance required in front of mounting panel is 6-3/4 inches (17.2cm).

Weight

32.5 pounds (14.7Kg) net, 48 pounds (21.8Kg) in shipping carton

Shipping Carton Dimensions

Width is 27 inches (68.6cm)

Depth is 25 inches (63.5cm)

Height is 14 inches (35.6cm)

Remote Control

McIntosh HR086

Packing the MCD12000

When shipping the MCD12000, it is highly recommended that the unit be packed as it was originally shipped to avoid damage. Failure to properly pack the unit will likely result in damage. (The front panel is made of glass!) If you need any of the packing material, you can contact McIntosh Customer Service. Use only packing material that is in good condition and replace any material that has seen better days.

It is very important that the four plastic feet are properly placed in the holes of the Foam Bottom Pad. This will ensure the proper equipment location for shipping. Failure to do this will result in shipping damage.

Quantity	Part Number	Description
1	033888	Shipping Carton
1	034692	Pad Bottom
1	034691	Foam Top - Inner Carton
1	033697	Inner Box
1	033739	Poly Bag
		20" W X 10" D X 36" L
4	034670	End Cap
4	017937	Plastic Foot
4	400159	10-32 X 3/4" Screw
4	404080	#10-7/16" Flat Washer

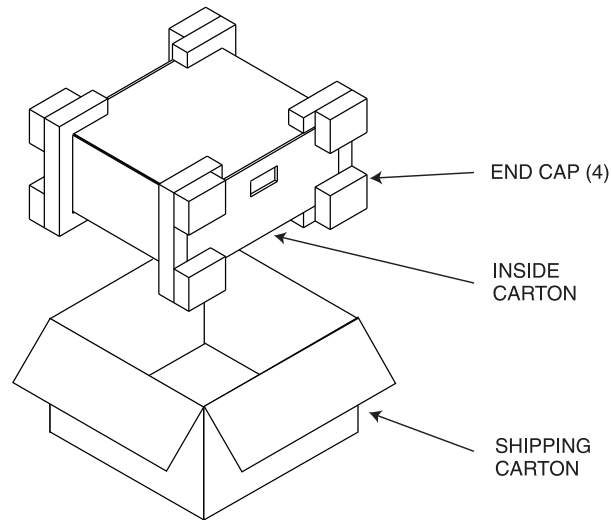
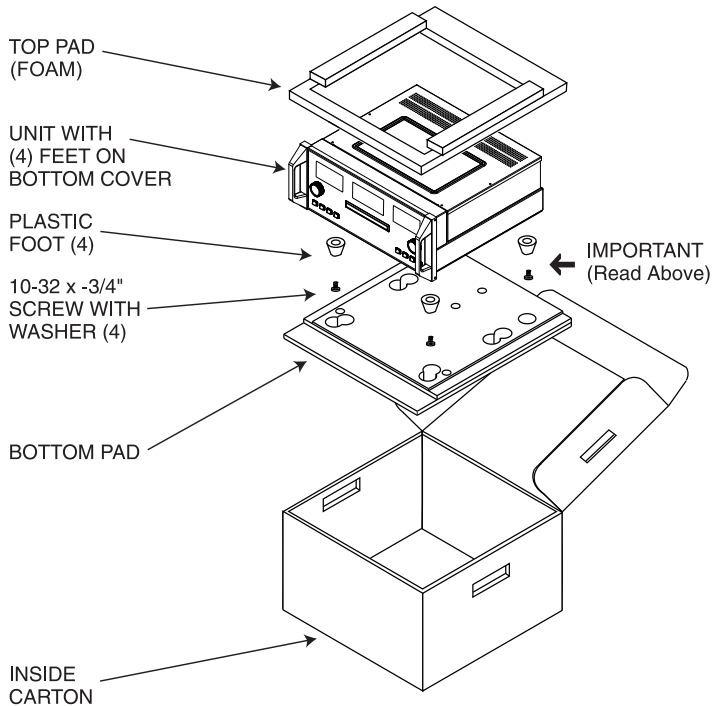



McIntosh Laboratory, Inc.
2 Chambers Street
Binghamton, NY 13903
www.mcintoshlabs.com

The continuous improvement of its products is the policy of McIntosh Laboratory Incorporated who reserve the right to improve design without notice.
Printed in the U.S.A.