



McIntosh Laboratory, Inc. 2 Chambers Street Binghamton, New York 13903-2699 Phone: 607-723-3512 www.mcintoshlabs.com



ML1

Loudspeaker System
Owner's Manual



The lightning flash with arrowhead, within an equilateral triangle, is intended to alert the user to the presence of uninsulated "dangerous voltage" within the product's enclosure that may be of sufficient magnitude to constitute a risk of electric shock to persons.

WARNING - TO REDUCE RISK OF FIRE OR ELECTRICAL SHOCK, DO NOT EXPOSE THIS EQUIPMENT TO RAIN OR MOISTURE



AVIS RISQUE DE CHOC ELECTRIQUE - NE PAS OUVRIR.
NO USER-SERVICEABLE PARTS INSIDE. REFER SERVICING TO QUALIFIED PERSONNEL

The exclamation point within an equilateral triangle is intended to alert the user to the presence of important operating and maintenance (servicing) instructions in the literature accompanying the appliance.

To prevent the risk of electric shock, do not remove cover or back. No user-serviceable parts inside.

IMPORTANT SAFETY INSTRUCTIONS!

PLEASE READ THEM BEFORE OPERATING THIS EQUIPMENT.

1. Read these instructions.
2. Keep these instructions.
3. Heed all warnings.
4. Follow all instructions.
5. Do not use this apparatus near water.
6. Clean only with a dry cloth.
7. Do not block any ventilation openings. Install in accordance with the manufacturer's instructions.
8. Do not install near any heat sources such as radiators, heat registers, stoves, or other apparatus (including amplifiers) that produce heat.
9. Do not defeat the safety purpose of the polarized or grounding-type plug. A polarized plug has two blades with one wider than the other. A grounding type plug has two blades and a third grounding prong. The wide blade or the

third prong are provided for your safety. If the provided plug does not fit into your outlet, consult an electrician for replacement of the obsolete outlet.

10. Protect the power cord from being walked on or pinched particularly at plugs, convenience receptacles, and the point where they exit from the apparatus.
11. Only use attachments/accessories specified by the manufacturer.
12. Use only with the cart, stand, tripod, bracket, or table specified by the manufacturer, or sold with the apparatus. When a cart is used, use caution when moving the cart/apparatus combination to avoid injury from tip-over.
13. Unplug this apparatus during lightning storms or when unused for long periods of time.
14. Refer all servicing to qualified service personnel. Servicing is required when the apparatus has been damaged in any way, such as power-supply cord or plug is damaged, liquid has been spilled or objects have fallen into the apparatus, the apparatus has been exposed to



rain or moisture, does not operate normally, or has been dropped.

15. Do not expose this equipment to dripping or splashing and ensure that no objects filled with liquids, such as vases, are placed on the equipment.
16. To completely disconnect this equipment from the AC mains, disconnect the AC / DC adapter from the AC receptacle.
17. The mains plug of the power supply cord shall remain readily operable. If the AC / DC Adapter is provided with a mains power supply cord attachment, the plug of this power supply cord shall remain readily operable.
18. Do not expose batteries to excessive heat such as sunshine, fire or the like.
19. Connect mains power supply cord only to a mains socket outlet with a protective earthing connection.

WARNING:

Use this product only with the Power Adapter provided. Failure to do so may result in fire and/or electrical shock.



Thank You from all of us at McIntosh

You have invested in a precision instrument that will provide you with many years of enjoyment. Please take a few moments to familiarize yourself with the features and instructions to get the maximum performance from your equipment.

If you need further technical assistance, please contact your dealer who may be more familiar with your particular setup including other brands. You can also contact McIntosh with additional questions or in the unlikely event of needing service.

McIntosh Laboratory, Inc.

2 Chambers Street
Binghamton, New York 13903

Technical Assistance (607) 723-3512
Fax (607) 724-0549

Customer Service (607) 723-3515
Fax (607) 723-1917

Email support@mcintoshlabs.com
www.mcintoshlabs.com

Table of Contents

General Information	3
Performance Features..	4
Introduction..	5
ML1 Stand	6
ML1 Stand Dimensions	6
ML1 Dimensions	7
Input Terminals	8
Unpacking the Loudspeaker	8
Installation	9
Loudspeaker Placement..	9
Home Theater Setup	9
Music System Setup	9
How to Connect Using One Amplifier	10
Connection Diagram (one amplifier)..	11
How to Connect Using Two Amplifiers..	12
Connection Diagram (two amplifiers)	13
Specifications	14
Packing Instructions	14
ML1 Packing Parts List..	15
Stand Packing Parts List.	15

General Information

Caution: The ML1 weight is 68.5 pounds (31.1 kg). It requires two or more persons to safely handle it.

- For additional connection information, refer to the owner’s manual(s) for any component(s) connected to the ML1.
- The ML1 has an American Walnut veneer which contains natural variations in wood grain giving each speaker a unique appearance.
- If there is an obvious lack of high, mid or low frequencies after extended periods of overdrive, the Protection Device(s) may have activated. These devices will automatically reset when the volume level is greatly reduced until the output of the affected Loudspeaker Driver(s) returns to normal.
- When discarding the unit, comply with local rules or regulations. Batteries should never be thrown away or incinerated but disposed of in accordance with the local regulations concerning battery disposal. 
- For additional information on the ML1 and other McIntosh products please visit the McIntosh website at www.mcintoshlabs.com.

Please Take A Moment

For future reference, you can write down your serial number and purchase information here.

We can identify your purchase from this information if the occasion should arise:

Serial Number: _____

Purchase Date: _____

Dealer Name: _____



Performance Features

• **Woofers with Patented LD/HP® Technology**

The McIntosh Low Frequency Loudspeaker Elements feature the patented LD/HP Magnetic Circuit Design. This design, when compared to conventional Loudspeaker Drivers, reduces distortion significantly. It also increases power handling and efficiency.

The rear vent through the magnetic assembly offers improved heat dissipation. The die cast basket has an open air area under the voice coil/spider assembly to prevent displacement noise. The polypropylene cone with a rubber surround has a four layer copper voice coil and is rigid to perform as a near perfect air piston.

All together these advances in woofer design construction and materials produce the very important first several octaves of music, with a high degree of accuracy and superb transient response. This performance level rivals woofers twice the size of the ML1 woofer.

• **Neodymium-Iron-Boron Alloy Magnets**

The 2 inch Midrange Driver and the ¾ inch Dome Super Tweeter all use this Alloy. The Neodymium-Iron-Boron Alloy has the highest flux density per unit of volume. This allows for a smaller physical size driver and thus closer driver to driver placement for improved dispersion.

• **Midrange Crossover Points**

The ML1 uses two types of midrange units: lower midrange/woofer and upper midrange. The midrange band has been broken up into two sections in order to aid the transition of output from the woofer to the upper midrange frequencies, and to reduce the amplitude requirements of a midrange driver at low frequencies while radiating higher frequencies, reducing doppler distortion. The upper 2" midrange unit was specially designed to have a low resonance so its crossover point can be lower than the typical 1 KHz of most loudspeakers, and span the critical vocal region of male and female singers.

Two 4 inch lower midranges are used in the ML1 to provide a symmetrical radiation pattern. This improves the listening window and sonic imaging.

• **Low Harmonic and Intermodulation Distortion**

The ML1 Loudspeaker System is capable of reproducing the full dynamic range of a symphony orchestra with very low audible distortion of any kind.

• **Sealed Enclosure**

The ML1 uses acoustic suspension design techniques. This type of loading was pioneered decades ago, and uses a linear air spring of the enclosure to keep distortion low, suspension under control at all times, and provide an extended low frequency output below resonance.

• **High Power Handling**

The Loudspeaker Elements and Crossover Components of the ML1 are all chosen for use with amplifiers up to 600 watts, yet can be driven with a 75 watt amplifier.

• **Loudspeaker Protection**

The ML1's built-in speaker protection incorporates four automatic resetting solid-state devices in the crossover network. One protects the tweeters, one each for the low and upper midrange drivers and one for the woofers.

• **Superior Imaging**

Locating the Super Tweeter between the multiple Midrange drivers generates a symmetrical polar response for superior imaging. The Midrange and Super Tweeter Drivers are precisely aligned and closely spaced on the precision machined mounting plate of 5/8 inch thick aluminium.

• **Versatile Operation**

In addition to the regular connections, the ML1 provides separate connections for bi-amplification and bi-wiring hookups.

• **McIntosh Custom Binding Posts**

McIntosh patented gold plated output terminals deliver high current output. They accept large diameter wire and spade lugs. Banana plugs may also be used in the US and Canada.

• **Loudspeaker Enclosure**

The ML1 enclosure is constructed with multiple front to back and side to side internal braces to form a dampened rigid Loudspeaker enclosure. The ML1 has a real wood veneer with a natural stain and mild satin finish..

• **Loudspeaker Grille**

The solid grille is a throwback to the original ML1 design using solid walnut, acoustically transparent cloth, and aluminum trim. The grille is held in place by several neodymium magnets.

Introduction

McIntosh Acoustic Engineers have achieved in the design of the ML1 Loudspeaker System, a level of high performance. The ML1 provides superior spaciousness sound reproduction with unusual sound stage depth in a full range system.

The enclosure is an important part of the ML1 Loudspeaker System. It has multiple front to back and side to side internal braces to form a dampened rigid Loudspeaker enclosure. The Loudspeaker's small footprint allows for a variety of different placements in a room.

The ML1 utilizes a 3/4 inch Titanium Dome Tweeter, a 2 inch soft dome upper midrange, two 4 inch lower mid/woofers, and a 12 inch high performance woofer. Since the audio power is distributed among all the drivers, each driver does not have to work as hard, resulting in greater power handling capability, dramatic reduction in distortion and greater dynamic range.



The Low Frequency Section of the System consists of a newly designed 12 inch Woofer.

The new 12 inch woofer incorporates McIntosh's patented LD/HP[®] Magnetic Circuit Design. Finite Element Analysis and testing resulted in a design concept which utilizes aluminum sleeves in the magnetic circuit.

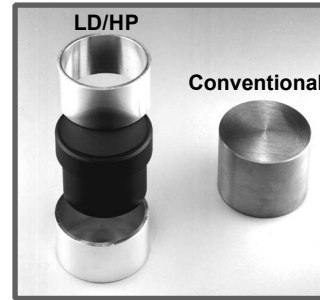

The sleeves greatly reduce the negative influence of the fluctuating voice coil field on the permanent magnet field. This results in lower distortion due to more linear magnetic flux in the voice coil gap.

Additional benefits are less volume compression due to improved heat transfer through the sleeves and a cooler operating voice coil. Both measurements, as well as critical listening, reveal ten times less distortion than previous designs. A good example of this low distortion is incredible smoothness and clarity in the reproduction of the human voice.

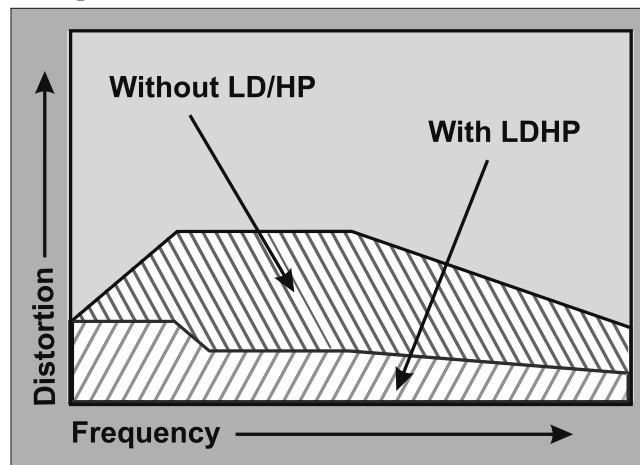

The Crossover Network used in the ML1 Loudspeaker System is designed to ensure an even frequency response over the entire audible range. The Second Order Designed Network utilizes capacitors and inductors with high current capacity. The ML1 uses low loss (DCR) inductors in the crossover network. The type of inductor used in each section of the crossover network has been chosen for high linearity, even at high power levels. This prevents distortion of the music at any frequency. The capacitors used are the low loss (ESR) types. The Network also utilizes self resetting high current PTC Fuses to provide an extra measure of protection.

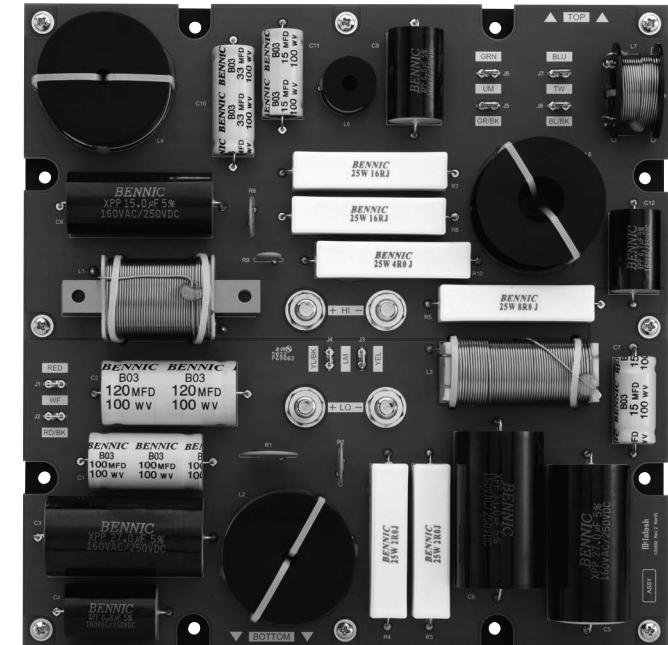



ML1 Stand

The dedicated stand for the ML1 has been designed to elevate and position the ML1 loudspeaker for optimum listening enjoyment and imaging. The stand comes with feet for use on hard floors, and spikes for use on carpet, etc.

ML1 Stand Dimensions

The following dimensions can assist in determining the best location for your ML1.

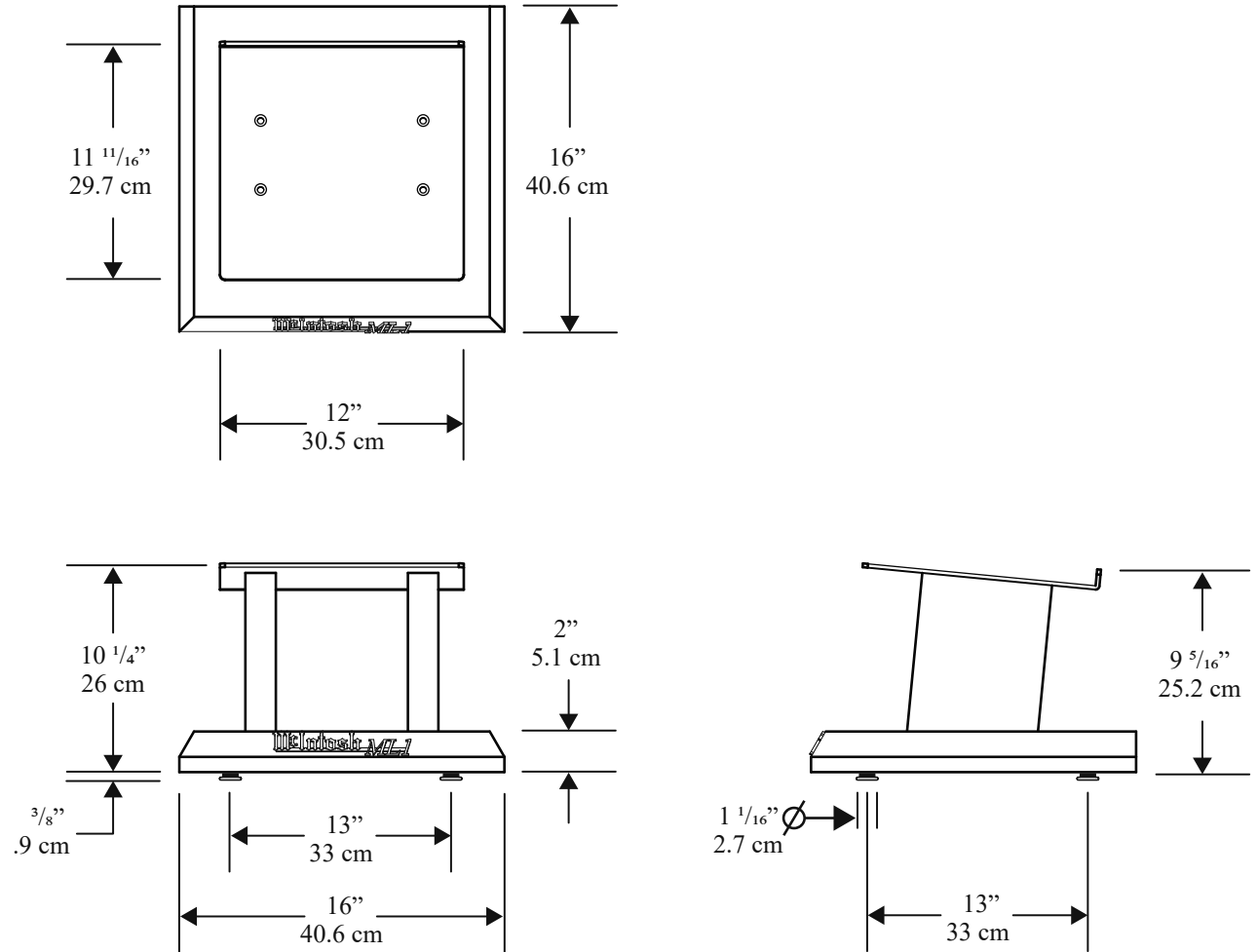

The following dimensions can assist in determining the best location for your ML1.

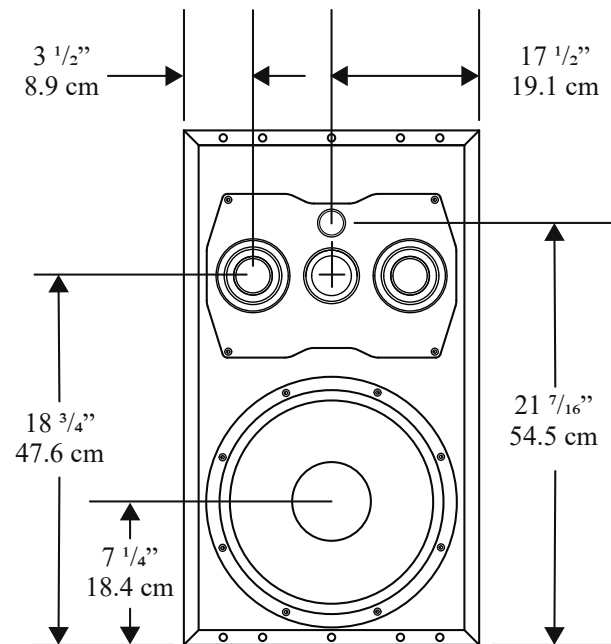
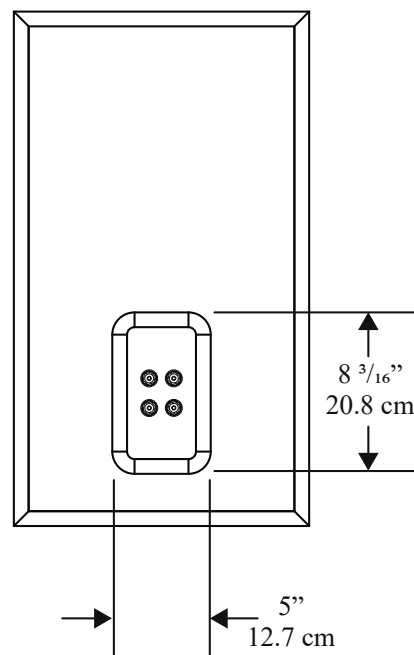
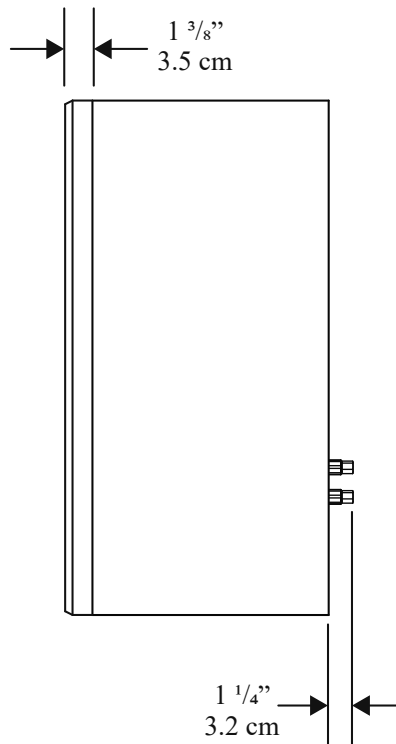
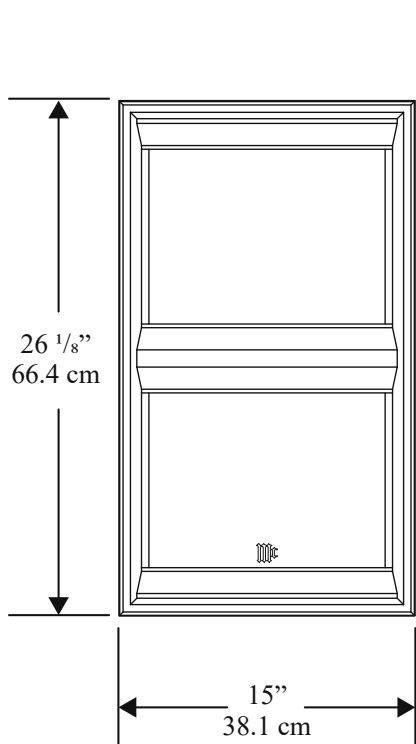
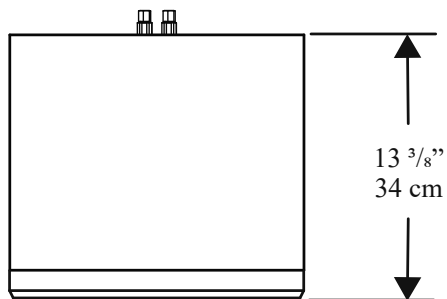



Input Terminals

When connecting the loudspeaker hookup cables to the amplifier output terminals please follow the steps below:

1. Rotate the top of the output terminal post counterclockwise until an opening appears.

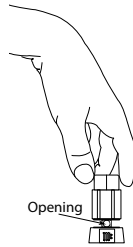

2. Insert the loudspeaker hookup cable into the output terminal post opening or the cable spade lug around the center post of the output terminal.



3. Rotate the top of the output terminal Post clockwise until it is finger tight.

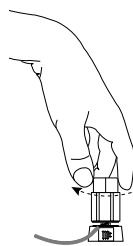

4. Place the supplied McIntosh wrench over the top of the output terminal and rotate it one quarter of a turn (90°) to secure the loudspeaker cable connection. **Do not over tighten.**

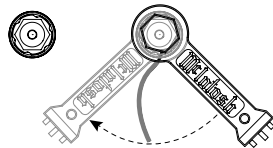

Unpacking the Loudspeaker, Stand, and Attaching the Feet

Caution: It is very important to install the four feet on the bottom of the stand. This will greatly prevent possible injury to small children and family pets. If the Loudspeaker is to be installed into custom cabinetry the stand need not be used.

To protect the fine finish of the ML1 during the installation process, it is advisable to prepare a suitable area. A freshly vacuumed carpeted area covered with a soft, clean fabric, such as a large bed linen or blanket would be suitable.

It is recommended that the professionals at your McIntosh Dealer, who are skilled in all aspects of installation and operation, install the ML1 and any associated audio equipment.

Note: Refer to illustration on page 15 for unpacking the loudspeaker.

1. Orient the ML1 shipping carton with the lettering on the outside of the carton oriented upward.
2. Carefully cut open the shipping carton sealing tape and open the carton flaps.
3. Place the shipping carton on a flat surface with the open flaps on the ground. Lift the shipping carton off the foam encapsulated ML1 speaker carefully.
4. Release the Loudspeaker and the Grille from the foam caps and set them aside.
5. Carefully remove the polybag from the ML1 and Grille so as not to mar the finish.

6. Repeat steps 1 and 2 on the ML1 Stand shipping carton and remove the stand from the carton.
7. Place the stand, with the front facing up, on top of the polybag.

8. Stand is pre-assembled with glides, use supplied spikes in place of glides by unscrewing glides from bottom of stand.

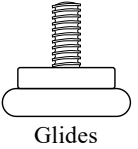

9. Turn the stand upright and place it in the desired location. The Glides or Spikes can be independently adjusted to compensate for uneven flooring or to aim the loudspeakers upward or downward.

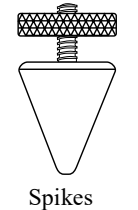

Note: Retain the shipping carton, foam packing material and polybag for possible future use.

10. Place the ML1 loudspeaker on top of each stand, and center on the top metal panel.
11. Orient the Loudspeaker Grille so the front Logo is at the bottom and oriented properly. Locate the grille on the bottom front of the cabinet and the internal magnets will draw tightly. Bring the top towards the cabinet and the grille will attach.

Installation

Loudspeaker Placement

Loudspeaker placement in a room can greatly affect performance. The ML1 loudspeaker is designed for both Music and Home Theater Systems. The optimal method for selecting speaker locations includes the use of a real time spectrum analyzer operated by an experienced system installer. An uncompromising installation would take into consideration the floor, wall and ceiling coverings, the type and placement of furniture and can even include the architectural design of the room and its construction materials. In those instances where placement in the room is fixed, an environmental equalizer may be needed to restore proper musical balance.

Placement near a wall, corner, floor, ceiling or any intersecting surfaces will reinforce or diminish some bass frequencies. The bass frequencies that are altered by placement in a particular location is dependent on the dimensions of the room. If professional measurement equipment is not available, listen to the Loudspeaker. Try various locations by listening to music containing continuous bass and finding a location where there is an over all musical balance in the sound and the bass content does not dominate.

The ML1's Smooth Frequency Response may be altered by a large object(s) located in the sound waves path or by locating the Loudspeaker too close to a side wall. There should be an unobstructed area in front of the Loudspeaker of at least 30 degrees either side from the center axis for the best performance. Refer to figure 9.

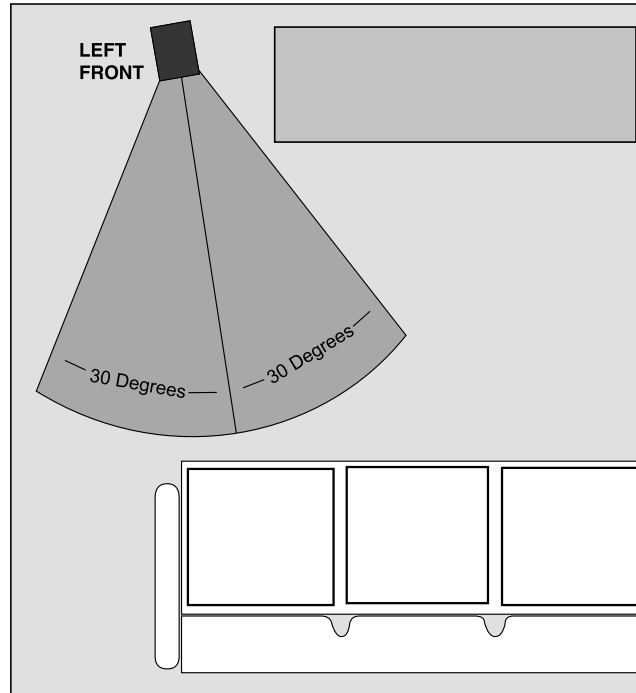

Figure 9

Locating Loudspeakers for use in Home Theater

In a Home Theater application, the placement of Left and Right Front Loudspeakers can be limited by such considerations as the size and location of the video monitor. The locating suggestions in the “for use in a Music System” section can still be helpful as a starting place. Refer to figure 10.

Locating Loudspeakers for use in a Music System

When used in a music system, the distance between the Loudspeakers and the listener to the Loudspeakers should form an equilateral or an acute isosceles triangle. If the speakers are too far apart relative to the listener, some imaging can be lost. Refer to figure 11.

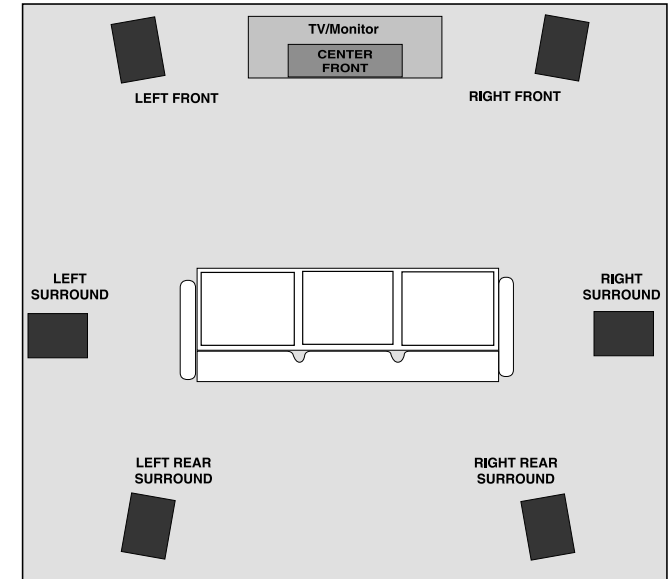

Figure 10

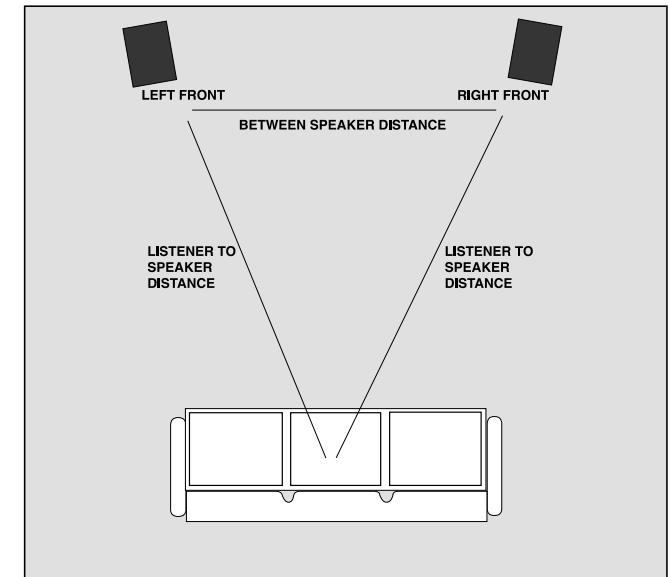

Figure 11



How to Connect Using One Amplifier

Caution: *The AC Power Cord should not be connected to the Amplifier until after the Loudspeaker Connections have been made. Failure to observe this could result in Electric Shock.*

When connecting a ML1 Loudspeaker to an amplifier it is very important to use cables of adequate size, so there is little to no power loss in the cables. The size is specified in Gauge Numbers or AWG (American Wire Gauge). The smaller the Gauge number, the larger the wire size:

Loudspeaker Cable Distance vs Wire Gauge Guide			
Loudspeaker Impedance	25 feet (7.62 meters) or less	50 feet (15.24 meters) or less	100 feet (30.48 meters) or less
2 Ohms	12AWG	10AWG	8AWG
4 Ohms	14AWG	12AWG	10AWG
8 Ohms	16AWG	14AWG	12AWG

Prepare Loudspeaker cables using the instructions below:

1. Carefully remove sufficient insulation from the cable ends, refer to figure 1. If the cable is stranded, carefully twist the strands together as tightly as possible.

Notes: 1. If desired, the twisted ends can be tinned with solder to keep the strands together.

2. The prepared bare wire cable ends may be inserted into spade lug connectors.

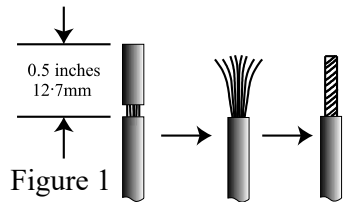

Figure 1

Select from the following options to connect the ML1:

Banana Plugs:

Caution: *Banana Plugs are for use in the United States and Canada only:*

2. Attach the previously prepared bare wire cable ends into the banana plugs and secure the connections. Refer to figure 2.

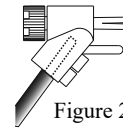

Figure 2

3. Rotate the top of the Output Terminal Post clockwise until it is finger tight. Refer to figure 3. Then using the McIntosh Wrench, rotate the top of the Output Terminal one quarter of a turn (90°). **Do not over tighten.**

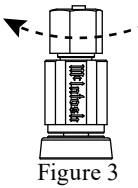

Figure 3

4. Referring to figure 4, connect the Loudspeaker hookup cables with banana plugs into the hole at the end of the terminal to the ML1 Negative (-) LOW Input Terminal and Positive (+) LOW Input Terminal.

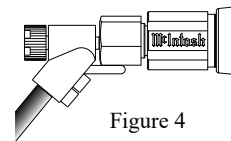

Figure 4

Note: It is important to maintain the correct polarity at both ends of the Loudspeaker cables.

5. Connect the other end of the Loudspeaker cables coming from the ML1 Negative (-) and Positive (+) LOW Input Terminals to the Left Channel Negative (-) and Positive (+) 8 Ω Output Terminal of the Amplifier.
6. Connect the second ML1 Loudspeaker in a similar manner to the Amplifier.

Spade Lug or Wire Connections:

2. Connect the Loudspeaker hookup cables to the ML1 Negative (-) Input Terminal and Positive (+) Input Terminal. Insert the spade lug connector or prepared section of the cable end into the Input Terminal side access hole, and tighten the Input Terminal cap until the cable is firmly clamped into the terminals so the lugs or wire cannot slip out. Refer to figures 5 and 6.

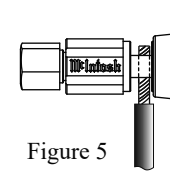

Figure 5

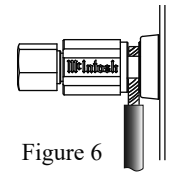
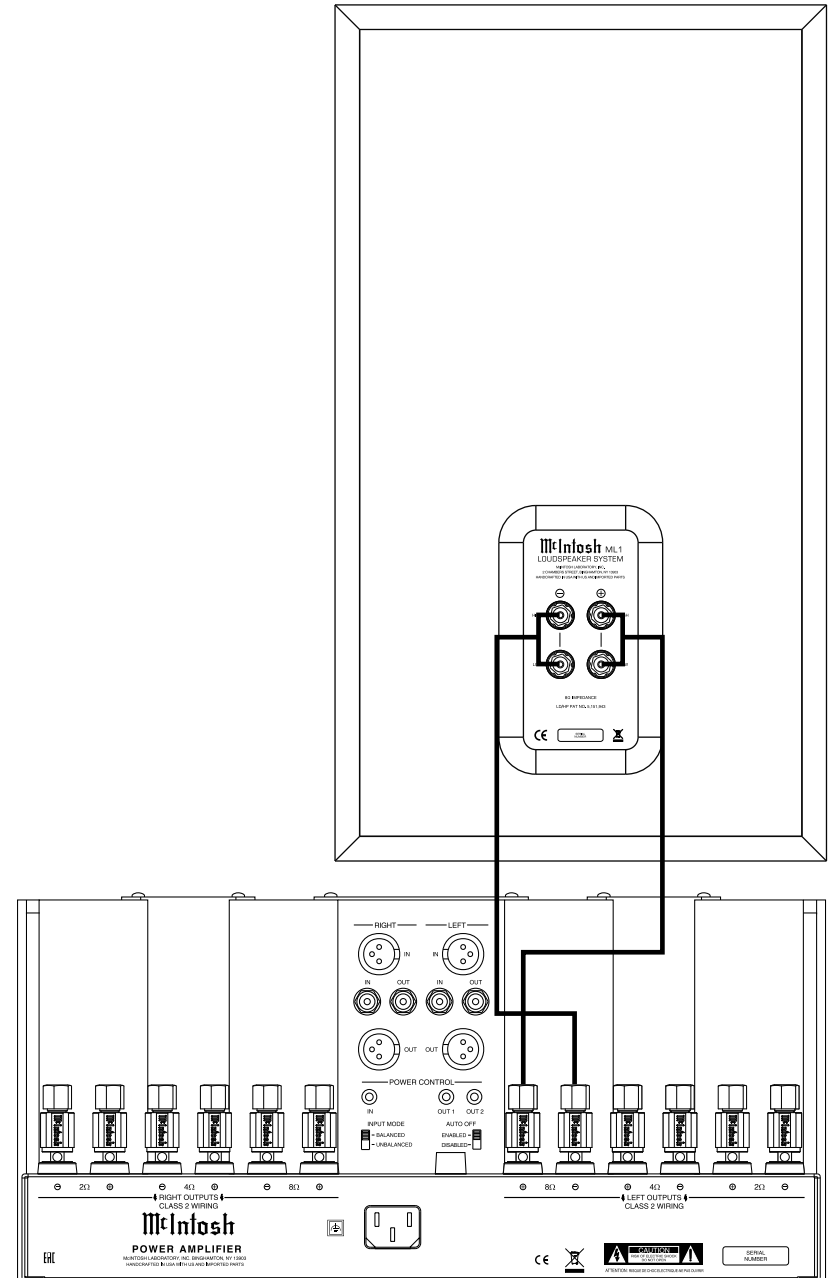

Figure 6

Note: It is important to maintain the correct polarity at both ends of the Loudspeaker cables.

3. Connect the other end of Loudspeaker cables coming from the ML1 Negative (-) LOW Input Terminal to the Left Channel COM (-) 8 Ω Output Terminal of the Amplifier.
4. In a similar manner, connect the Loudspeaker cables coming from the second ML1 Positive (+) LOW Input Terminal to the Left Channel 8 Ω (+) Output Terminal of the Amplifier.
5. Connect the second ML1 Loudspeaker in a similar manner to the Amplifier's Right Channel Terminals.

Connection Diagram (one amplifier)





How to Connect Using Two Amplifiers

Caution: The AC Power Cord should not be connected to the Amplifier until after the Loudspeaker Connections have been made. Failure to observe this could result in Electric Shock.

Note: When the ML1 Loudspeaker System is driven by two amplifiers, the output levels of different model amplifiers connected to the Loudspeaker System must be adjusted to achieve a proper balance between the low and midrange/high frequencies reproduced. This adjustment is best achieved through the use of audio test equipment operated by a qualified installer.

When connecting a ML1 Loudspeaker to two amplifiers it is very important to use cables of adequate size, so there is little to no power loss in the cables. The size is specified in Gauge Numbers or AWG (American Wire Gauge). The smaller the Gauge number, the larger the wire size:

Loudspeaker Cable Distance vs Wire Gauge Guide			
Loudspeaker Impedance	25 feet (7.62 meters) or less	50 feet (15.24 meters) or less	100 feet (30.48 meters) or less
2 Ohms	12AWG	10AWG	8AWG
4 Ohms	14AWG	12AWG	10AWG
8 Ohms	16AWG	14AWG	12AWG

Prepare Loudspeaker cables using the instructions below:

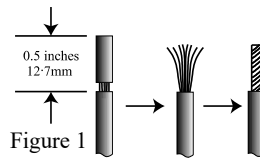

- Carefully remove sufficient insulation from the cable ends, refer to figure 1. If the cable is stranded, carefully twist the strands together as tightly as possible.

Notes: 1. If desired, the twisted ends can be tinned with solder to keep the strands together.
2. The prepared bare wire cable ends may be inserted into spade lug connectors.

- Remove the ML1 metal jumpers between the Negative (-) LOW and HIGH/MID Terminals and between the Positive (+) LOW and HIGH/MID terminals. Retain them for possible future use.

Select from the following options to connect the ML1:

Banana Plugs:

Caution: Banana Plugs are for use in the United States and Canada only:

- Attach the prepared bare wire cable ends into the banana plugs and secure the connections. Refer to figure 2.
- Rotate the top of the Output Terminal Post clockwise until it is finger tight. Refer to figure 3. Then using the McIntosh Wrench, rotate the top of the Output Terminal one quarter of a turn (90°). **Do not over tighten.**
- Referring to figure 4, connect the Loudspeaker hookup cables with banana plugs into the hole at the end of the ML1 LOW Negative (-) and Positive (+) Input Terminals. Then connect cables to the ML1 HIGH/MID Negative (-) and Positive (+) Input Terminals.

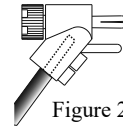

Figure 2

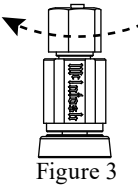

Figure 3

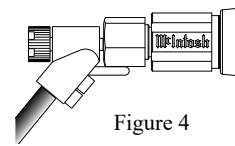

Figure 4

Note: It is important to maintain the correct polarity at both ends of the Loudspeaker cables.

- Connect cables from the ML1 LOW Terminals to the Left Channel Negative (-) and Positive (+) 8 Ω Output Terminals of Power Amplifier Two. Then connect cables from the ML1 HIGH/MID Terminals to the Left Channel Negative (-) and Positive (+) 8 Ω Output Terminals of Power Amplifier One.
- Connect the other Loudspeaker in a similar manner to the Right Channel Output Terminals of the Power Amplifiers.

Spade Lug or Wire Connections:

- Referring to the illustration connect the Loudspeaker hookup cables to the ML1 Negative (-) Input Terminal and Positive (+) Input Terminal. Insert the spade lug connector or prepared section of the cable end into the Input Terminal side access hole, and tighten the Input Terminal cap until the cable is firmly clamped into the terminals so the lugs or wire cannot slip out. Refer to figures 5 and 6. Then connect cables to the ML1 HIGH/MID Negative (-) and Positive (+) Input Terminals.

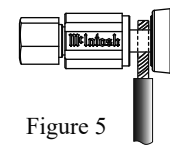

Figure 5

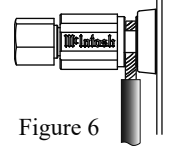
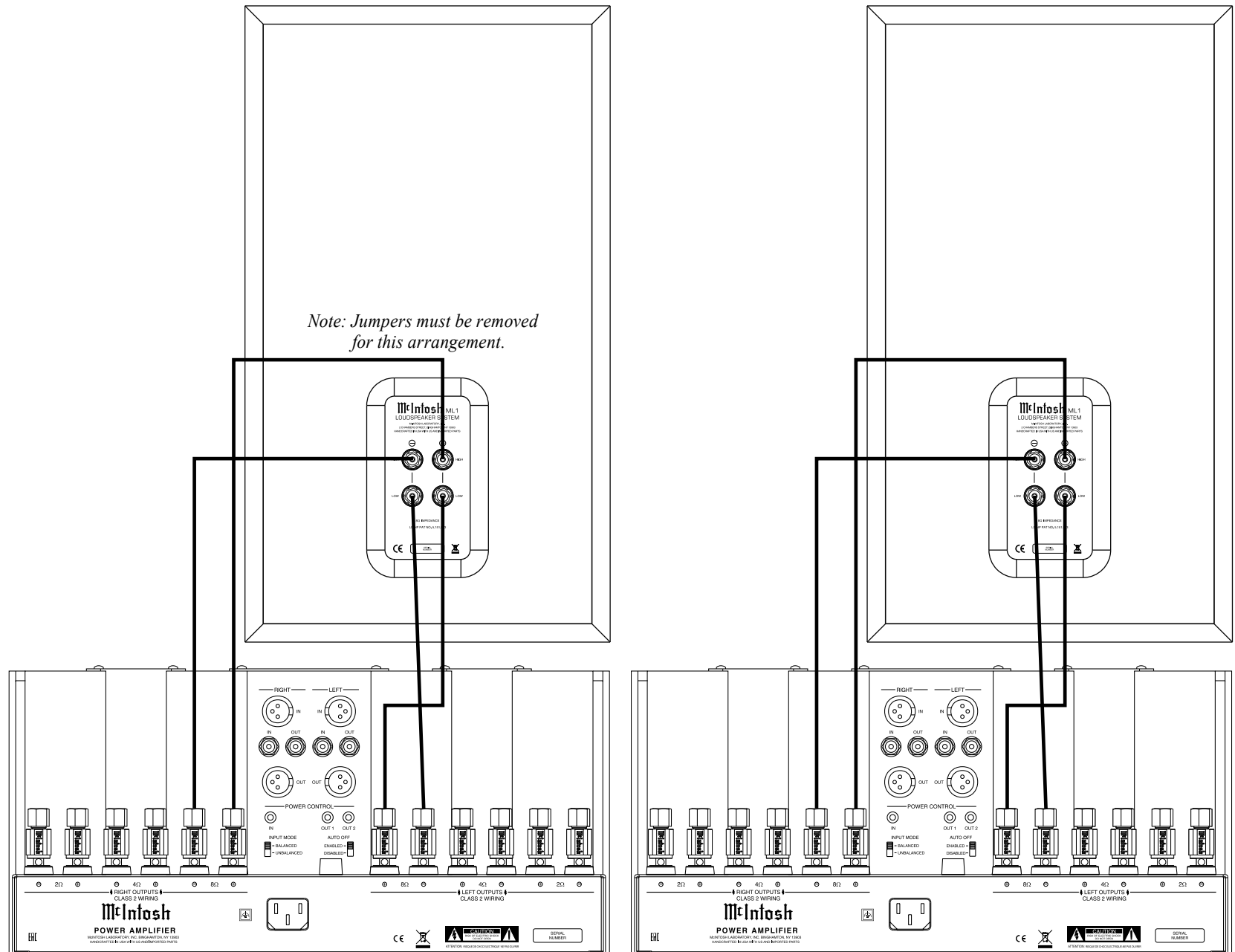

Figure 6

Note: It is important to maintain the correct polarity at both ends of the Loudspeaker cables.

- Connect cables from the ML1 LOW Terminals to the Left Channel Negative (-) and Positive (+) 8 Ω Output Terminals of Power Amplifier Two. Then connect cables from the ML1 HIGH/MID Terminals to the Left Channel Negative (-) and Positive (+) 8 Ω Output Terminals of Power Amplifier One.
- Connect the other Loudspeaker in a similar manner to the Right Channel Output Terminals of the Power Amplifiers.

Connection Diagram (two amplifiers)





Specifications

System Driver Complement

One 12 inch Woofer (incorporating LD/HP)
One 2 inch soft dome Upper Midrange
Two 4 inch lower midranges
One ¾ inch Titanium Dome Tweeter

Impedance

8 ohms Nominal

Frequency Response

27Hz - 45,000Hz

Sensitivity

85 dB (2.83V/1m equivalent)

Crossover Frequencies

180Hz
500Hz
4500Hz

Recommended Power Range

75 Watts to 600 Watts

Maximum Power Handling

600 Watts

General Specifications

Enclosure Finish

American Walnut veneers and solids with satin finish

Grille Finish

Solid American Walnut with satin finish, black knit cloth with aluminum trim

ML1 Dimensions

Width is 15 inches (38.1cm)
Height is 26 ⅛ inches (66.4cm)
Depth is 13 ⅜ inches (34cm)

Stand Dimensions

Width is 16 inches (40.6cm)
Height is 16 inches (40.6cm)
Depth is 7 ⅞ inches (20cm)

ML1 Weight

66 pounds (30 kg) net
75.3 pounds (34.2 kg) in shipping carton

Stand Weight

19 pounds (8.6 kg) net
25.3 pounds (11.5 kg) in shipping carton

ML1 Shipping Carton Dimensions

Width is 20 ½ inches (52.1cm)
Depth is 20 ½ inches (52.1cm)
Height is 30 ½ inches (77.5cm)

Stand Shipping Carton Dimensions

Width is 20 ½ inches (52.1cm)
Depth is 20 ½ inches (52.1cm)
Height is 15 ½ inches (38.6cm)

Packing Instructions

In the event it is necessary to repack the equipment for shipment, the equipment must be packed exactly as shown below.

Use the original shipping carton and interior parts only if they are all in good serviceable condition. If a shipping carton or any of the interior part(s) are needed, please call or write Customer Service Department of McIntosh Laboratory. Refer to page 3. Please see the packing part lists on the following page for the correct part numbers.

ML1 Packing Parts List

Qty	Part Number	Description
1	034701	Shipping Carton only
2	034702	Foam Tray Top/Bottom
1	034703	Foam Support Center
1	034718	Poly Bag (Speaker)
1	034719	Poly Bag (Grille)

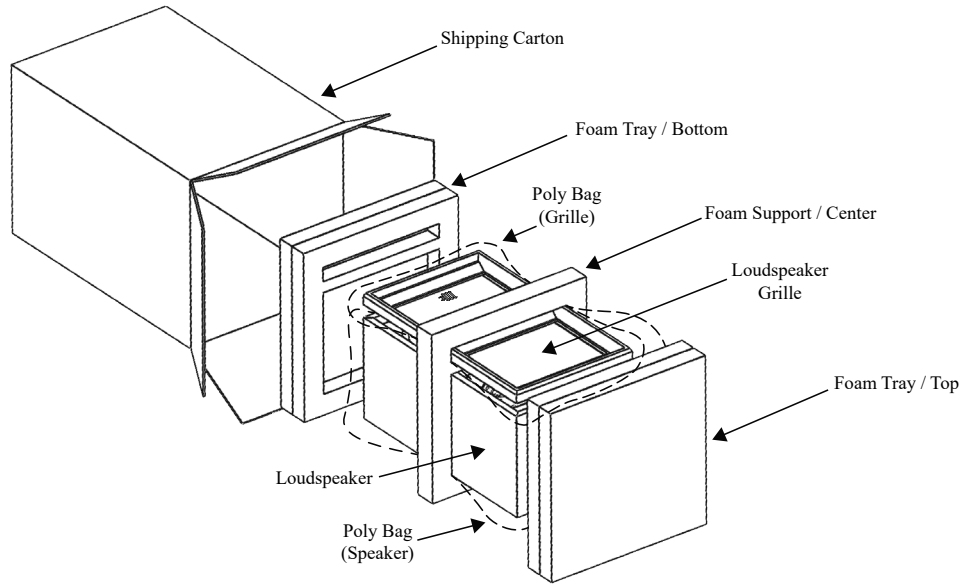

ML1 Stand Packing Parts List

Qty	Part Number	Description
1	034714	Shipping Carton Speaker Stand
2	034712	Foam End Cap Stand
1	034718	Poly Bag (Speaker)
4	414174	Cabinet Spikes
1	033545	Bag Zip Loc 4x4

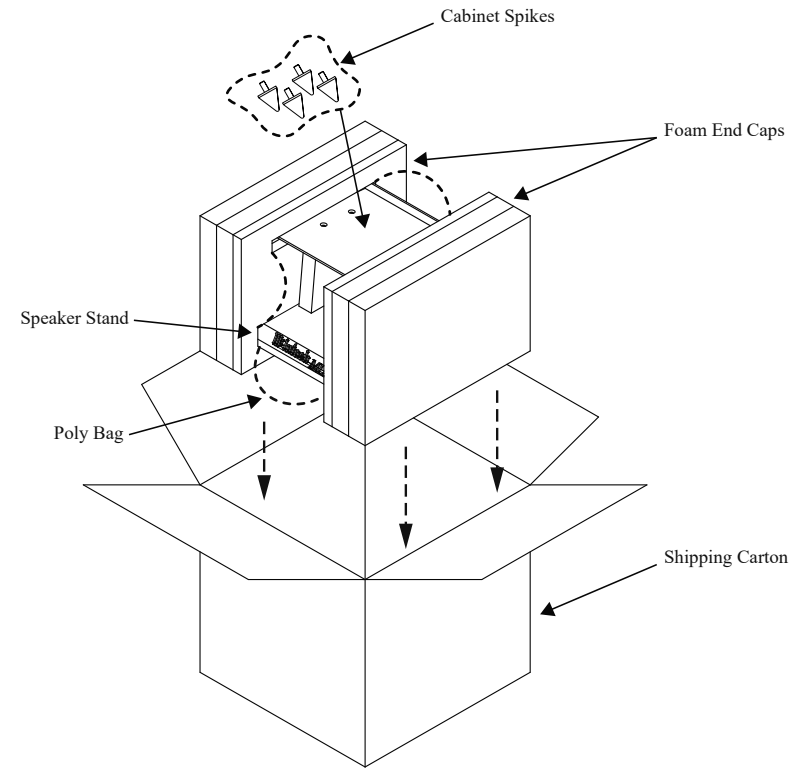



McIntosh Laboratory, Inc.
2 Chambers Street
Binghamton, NY 13903
www.mcintoshlabs.com

The continuous improvement of its products is the policy of McIntosh Laboratory Incorporated who reserve the right to improve design without notice.

Printed in the U.S.A.