



McIntosh Laboratory, Inc. 2 Chambers Street Binghamton, New York 13903-2699 Phone: 607-723-3512 www.mcintoshlabs.com

MB50  
Streaming Audio Player  
Owner's Manual



The lightning flash with arrowhead, within an equilateral triangle, is intended to alert the user to the presence of uninsulated "dangerous voltage" within the product's enclosure that may be of sufficient magnitude to constitute a risk of electric shock to persons.

**WARNING - TO REDUCE RISK OF FIRE OR ELECTRICAL SHOCK, DO NOT EXPOSE THIS EQUIPMENT TO RAIN OR MOISTURE.**

## IMPORTANT SAFETY INSTRUCTIONS!

**PLEASE READ THEM BEFORE OPERATING THIS EQUIPMENT.**

1. Read these instructions.
2. Keep these instructions.
3. Heed all warnings.
4. Follow all instructions.
5. Do not use this apparatus near water.
6. Clean only with a dry cloth.
7. Do not block any ventilation openings. Install in accordance with the manufacturer's instructions.
8. Do not install near any heat sources such as radiators, heat registers, stoves, or other apparatus (including amplifiers) that produce heat.
9. Do not defeat the safety purpose of the polarized or grounding-type plug. A polarized plug has two blades with one wider than the other. A grounding type plug has two blades and a third grounding prong. The wide blade or the third prong are provided for your safety. If the provided plug does not fit into your outlet, consult an electrician for replacement of the obsolete outlet.
10. Protect the power cord from being walked on or pinched particularly at plugs, convenience receptacles, and the point where they exit from the apparatus.
11. Only use attachments/accessories specified by the manufacturer.
12. Use only with the cart, stand, tripod, bracket, or table specified by the manufacturer, or sold with the apparatus. When a cart is used,



**ATTENTION:**  
RISQUE DE CHOC ELECTRIQUE - NE PAS OUVRIR  
**NO USER-SERVICEABLE PARTS INSIDE. REFER SERVICING TO QUALIFIED PERSONNEL.**

- use caution when moving the cart/apparatus combination to avoid injury from tip-over.
13. Unplug this apparatus during lightning storms or when unused for long periods of time.
  14. Refer all servicing to qualified service personnel. Servicing is required when the apparatus has been damaged in any way, such as power-supply cord or plug is damaged, liquid has been spilled or objects have fallen into the apparatus, the apparatus has been exposed to rain or moisture, does not operate normally, or has been dropped.
  15. Do not expose this equipment to dripping or splashing and ensure that no objects filled with liquids, such as vases, are placed on the equipment.  
Ne pas exposer cet appareil à des éclaboussures ou gouttelettes d'un liquide. Aucun objet remplie de liquide comme par exemple un vase ne doit être placé sur l'appareil.
  16. If this equipment is supplied with a power supply cord only, the mains plug of the power supply cord shall remain readily operable. To completely disconnect this equipment from the a.c. mains remove the plug from the a.c. receptacle.  
Si l'équipement est uniquement alimenté par un cordon d'alimentation, la fiche du cordon d'alimentation doit demeurer aisément accessible. Pour déconnecter complètement l'équipement du réseau d'alimentation, déconnecter la fiche du cordon d'alimentation de la prise murale.

The exclamation point within an equilateral triangle is intended to alert the user to the presence of important operating and maintenance (servicing) instructions in the literature accompanying the appliance.

**To prevent the risk of electric shock, do not remove cover or back. No user-serviceable parts inside.**

17. If this equipment is supplied with AC /DC Adapter with separate power supply cord or the AC/DC Adapter plugging directly into an a.c. receptacle, they shall remain readily operable. To completely disconnect this equipment from the a.c. mains remove the AC /DC Adapter mains power supply cord from the a.c. receptacle or remove the AC /DC Adapter when it is directly plugged into the a.c. receptacle.  
Si l'équipement est alimenté par un adaptateur AC/DC munis d'un cordon d'alimentation ou un adaptateur AC/DC qui est alimenté directement à la prise murale, ils doivent demeurer aisément accessibles. Pour déconnecter complètement l'équipement du réseau d'alimentation, déconnecter l'adaptateur AC/DC de la prise murale ou déconnecter le cordon d'alimentation de l'adaptateur AC/DC de la prise murale.
18. **WARNING:** Do not expose batteries or battery pack to excessive heat such as sunshine, fire or the like.  
**AVERTISSEMENT:** Les batteries ou bloc de batteries ne doivent pas être exposées à une chaleur excessive telle que celle du soleil, feu ou autre source de chaleur similaire.
19. **CAUTION:** danger of explosion if battery is incorrectly replaced. Replace only with the same or equivalent type.  
**ATTENTION:** danger d'explosion si la pile n'est pas remplacée correctement. Ne remplacer que par le même type ou un type équivalent.
20. Connect mains power supply cord only to a mains socket outlet with a protective earthing connection.

**FCC INFORMATION (For US and Canada Customers)**

a) User Information acc. to FCC15.21 as following:  
Changes or modifications not expressly approved by the party responsible for compliance could void the user’s authority to operate the equipment.

b) Statement for Class B digital device acc. to FCC 15.105 as following:

NOTE: This equipment has been tested and found to comply with the limits for a Class A/B digital device, pursuant to part 15 of the FCC Rules. These limits are designed to provide reasonable protection against harmful interference in a residential installation. This equipment generates, uses and can radiate radio frequency energy and, if not installed and used in accordance with the instructions, may cause harmful interference to radio communications. However, there is no guarantee that interference will not occur in a particular installation. If this equipment does cause harmful interference to radio or television reception, which can be determined by turning the equipment off and on, the user is encouraged to try to correct the interference by one or more of the following measures:

- Reorient or relocate the receiving antenna.
- Increase the separation between the equipment and receiver.
- Connect the equipment into an outlet on a circuit different from that to which the receiver is connected.
- Consult the dealer or an experienced radio/ TV technician for help.
- This device complies with Industry Canada licence-exempt RSS standard(s). Operation is subject to the following two conditions: (1) this device may not cause interference, and (2) this device must accept any interference, including interference that may cause undesired operation of the device.



Le présent appareil est conforme aux CNR d’Industrie Canada applicables aux appareils radio exempts de licence. L’exploitation est autorisée aux deux conditions suivantes : (1) l’appareil ne doit pas produire de brouillage, et (2) l’utilisateur de l’appareil doit accepter tout brouillage radioélectrique subi, même si le brouillage est susceptible d’en compromettre le fonctionnement.

c) The device must be kept more than 20 cm from all persons.

**Trademark and License Information**

The McIntosh MB50 incorporates copyright protected technology that is protected by U.S. patents and other

intellectual property rights. The MB50 uses the following Technologies:

Trademark Logo	License Information
	<p>For DTS patents, see <a href="http://patents.dts.com">http://patents.dts.com</a>. Manufactured under license from DTS, Inc. DTS, Play-Fi, the Symbol, and Play-Fi together in combination with the Symbol are trademarks of DTS, Inc. DTS and Play-Fi are registered trademarks of DTS, Inc. © DTS, Inc. All Rights Reserved.</p>
	<p>The Wi-Fi CERTIFIED Logo is a certification mark of the Wi-Fi Alliance.</p>



## Thank You

Your decision to own this McIntosh MB50 Streaming Audio Player ranks you at the very top among discriminating music listeners. You now have the best. The McIntosh dedication to precision performance assures many years of musical enjoyment. Please take a short time to read the information in this guide. We want you to be as familiar as possible with all the features and functions of your new McIntosh.

## Please Take A Moment

The serial number, purchase date and McIntosh Dealer name are important to you for possible insurance claim or future service. The spaces below have been provided for you to record that information:

Serial Number: \_\_\_\_\_

Purchase Date: \_\_\_\_\_

Dealer Name: \_\_\_\_\_

## Technical Assistance

If at any time you have questions about your McIntosh product, contact your McIntosh Dealer who is familiar with your McIntosh equipment and any other brands that may be part of your system. If you or your Dealer wish additional help concerning a suspected problem, you can receive technical assistance for all McIntosh products at:

McIntosh Laboratory, Inc.  
2 Chambers Street  
Binghamton, New York 13903  
Phone: 607-723-3512  
Fax: 607-724-0549

## Customer Service

If it is determined that your McIntosh product is in need of repair, you can return it to your Dealer. You can also return it to the McIntosh Laboratory Service Department. For assistance on factory repair return procedure, contact the McIntosh Service Department at:

McIntosh Laboratory, Inc.  
2 Chambers Street  
Binghamton, New York 13903  
Phone: 607-723-3515  
Fax: 607-723-1917

## Table of Contents

Safety Instructions.....	2
FCC Information, Trademark and License Information.....	3
Thank You and Please Take a Moment.....	4
Technical Assistance and Customer Service.....	4
Table of Contents.....	4
General Information.....	5
Connector and Cable Information.....	5
Introduction.....	6
Performance Features.....	6
Dimensions.....	7
Installation.....	8
Rear Panel Connections and AC/DC Adapter.....	9
Connecting to a Preamp/ifier or A/V Control Center.....	10
Connecting to a Power Amplifier.....	11
Front Panel Display and Push-buttons.....	12
How to use the Remote Control.....	13
How to Set Up the MB50 for Play-Fi.....	14-15
How to Operate the MB50.....	16-20
Photos.....	21
Specifications.....	22
Packing Instructions.....	23

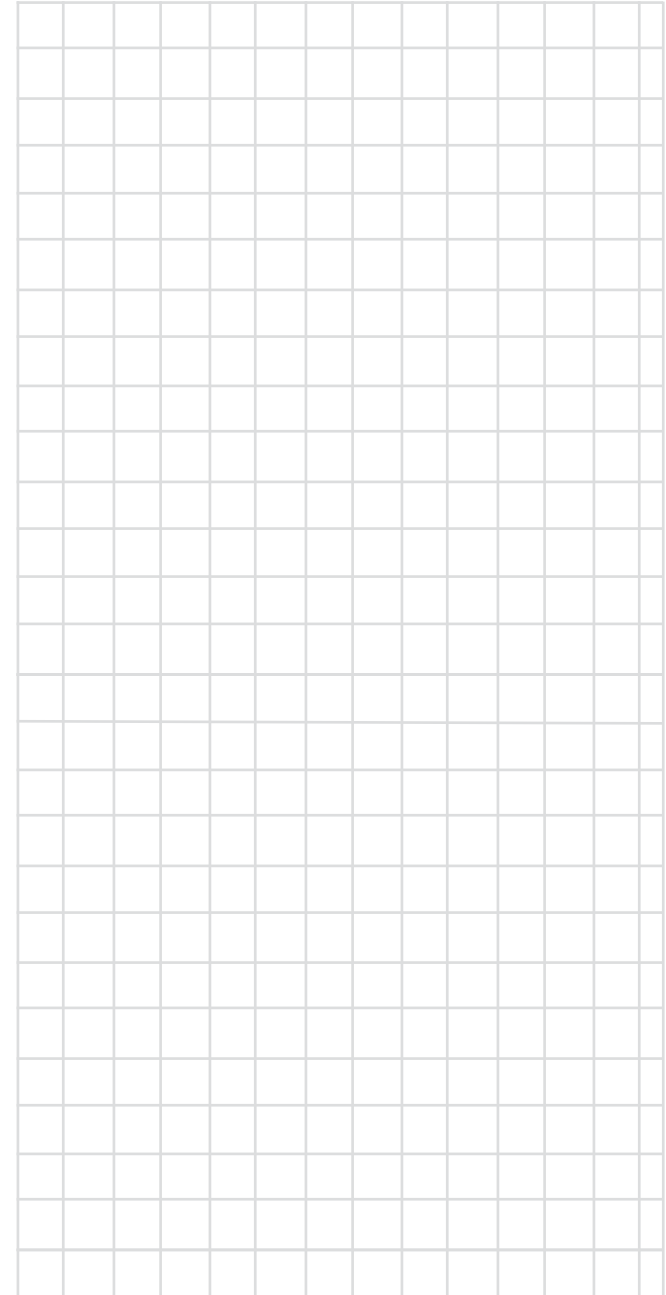

## General Information

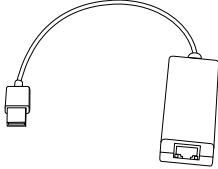
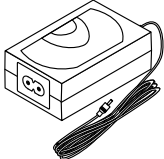
- For additional connection information, refer to the owner's manual(s) for any component(s) connected to the MB50 Streaming Audio Player.
- For the MB50 to receive streaming audio signals from a mobile device, a wireless router with Wi-Fi capabilities is required, in order to facilitate communications between the MB50 and the mobile device.
- When connecting the MB50 to a wired Home Computer Network (of which includes a wireless router) a USB (2.0) to Ethernet (RJ45) Adapter such as a Monoprice (109466) is required.
 
- The MB50 internal Digital Circuitry is designed for 2-channel PCM (Pulse Code Modulation) Digital Audio Signals.
- The MB50 is designed to be compatible with the majority of Audio Power Amplifiers. However, do to a wide range of Power Amplifier Designs, it is important the input sensitivity of the amplifier be at least 2 Volts. This will assure music recordings are reproduced with adequate dynamic range. This will assure the playback of most music recordings are reproduced with adequate dynamic range. Check with your McIntosh Dealer for additional information.
- If it should become necessary to replace the supplied AC / DC Power Adapter, for use in North America order part number 75190800. The Power Adapter for use in other countries, order part number 75177200. Both Power Adapters are available from the McIntosh Parts Department.
 

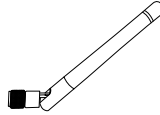
- For proper wireless operation the MB50 requires connection of both WLAN Antennas. If it should become necessary to replace one of the supplied Antennas, order part number 12245600 from the McIntosh Parts Department.
 
- The performance of the MB50 is dependent upon the speed and operational range of the Wireless Router used.
- When the MB50 is connected to a wired Home Computer Network with a Wireless Router, the speed should be 1 Gigabit or faster.
- The Play-Fi App for Streaming Music and Remote Control Operation of the MB50 is available at Web Sites for download free of charge:
 

For Apple Powered Mobile Devices:  
<https://itunes.apple.com/us/app/play-fi/id779245456?mt=8>

For Android Powered Mobile Devices:  
<https://play.google.com/store/apps/details?id=com.phorus.playfi&hl...>
- When there is an update to the Play-Fi App used by the MB50, new functionality may be added. Information about the new functionality would not be covered in this edition of the MB50 Owners Manual. Please refer to the Play-Fi Web Site and the McIntosh Web Site for updated information:
 

<https://www.play-fi.com> - (Knowledge Base)

<http://www.mcintoshlabs.com> - (Products)
- When discarding the unit, comply with local rules or regulations. Batteries should never be thrown away or incinerated but disposed of in accordance with the local regulations concerning battery disposal.
 
- Periodically, check the McIntosh Web Site at [www.mcintoshlabs.com](http://www.mcintoshlabs.com) for the latest information on the MB50 and other McIntosh Products.

## Connector and Cable Information

### XLR Connectors

Below is the Pin configuration for the XLR Balanced Output Connectors on the MB50. Refer to the diagram for connection:

- PIN 1: Shield/Ground
- PIN 2: + Output
- PIN 3: - Output

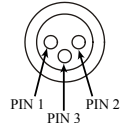

### Power Control Connector

The Trigger Input Jack receives Power On/Off Signals (+12 volt/0 volt) when connected to other McIntosh Components. The Trigger Output Jack sends Power On/Off Signals (+12 volt/0 volt) when connected to other McIntosh Components. An additional connection is for controlling the illumination of the Power Output Meters on McIntosh Power Amplifiers. A 3.5mm stereo mini phone plug is used for connection to the Power Control Jacks.

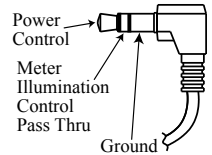



## Introduction

The McIntosh MB50 Streaming Audio Player offers the latest in audio technology, providing state of the art audio reproduction from your Audio Mobile and other Devices. When the MB50 is added to a McIntosh System, the music from this source may be enjoyed in your home. The advanced design ensures many years of smooth trouble free operation.

## Performance Features

### • Built-in Networking Capability

The MB50 has the ability to connect to an existing network for connecting to other devices such as NAS Storage Devices.

### • Critical Listening Mode

Retains the original quality of High Resolution Audio Files up to 96kHz/24 bit, while streaming the music via Play-Fi. The Critical Listening Mode removes any Wi-Fi Artifacts like Network Jitter.

### • Line In Streaming

The MB50 has the ability to stream the audio from the selected Audio Input (Digital or Analog) via the Play-Fi App to Wireless Loudspeaker Systems, such as the McIntosh RS100, located in another room.

### • Internet Streaming Radio

The MB50 also allows for listening to Internet Radio Stations when connected to a mobile device using the Play-Fi App.

### • Local AM/FM Radio Stations

The MB50 also allows for listening to local AM/FM Stations via the Internet when connected to a mobile device using the Play-Fi App.

### • Digital Audio Inputs and Outputs

There are Coaxial and Optical Digital Audio Inputs and Outputs for connection to other components.

### • Unbalanced Analog Inputs and Outputs

The MB50 has both unbalanced Inputs and Outputs for compatibility with a wide range of audio components.

### • Balanced Analog Outputs

The MB50 has Balanced Outputs which permit long cable lengths without a loss in sound quality.

### • Trigger Control

The Trigger Control Input connection provides convenient Turn-On/Off of the MB50 when connected to a McIntosh System with Power Control.

### • Remote Control

The Remote Control provides operation of the MB50 operating functions when using contemporary components.

### • Fiber Optic Solid State Front Panel Illumination

The even Illumination of the Front Panel is accomplished by the combination of custom designed Fiber Optic Light Diffusers and extra long life Light Emitting Diodes (LEDs).

### • Glass Front Panel and Super Mirror Chassis Finish

The famous McIntosh Illuminated Glass Front Panel and the Stainless Steel Chassis with Super Mirror Finish ensures the pristine beauty of the MB50 will be retained for many years.





### Dimensions

The following dimensions can assist in determining the best location for your MB50.

Front View of the MB50

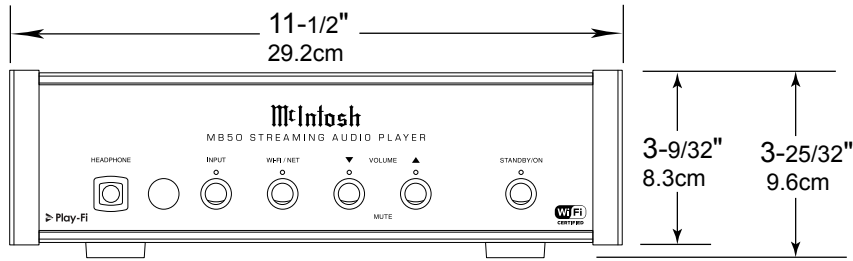

Side View of the MB50

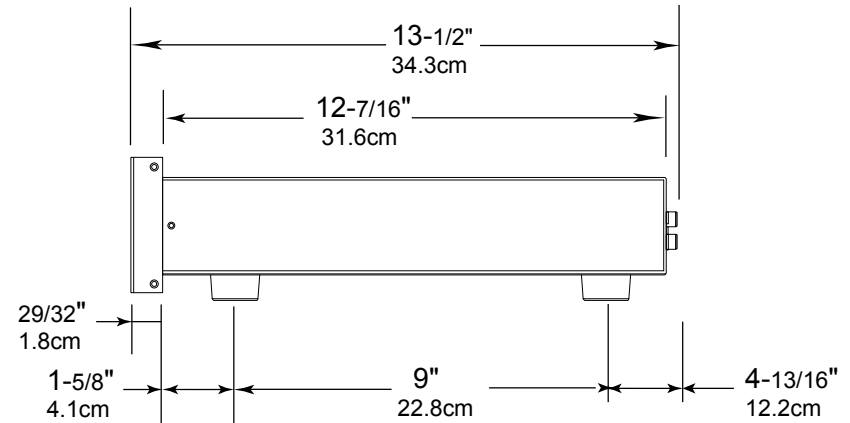

Rear View of the MB50

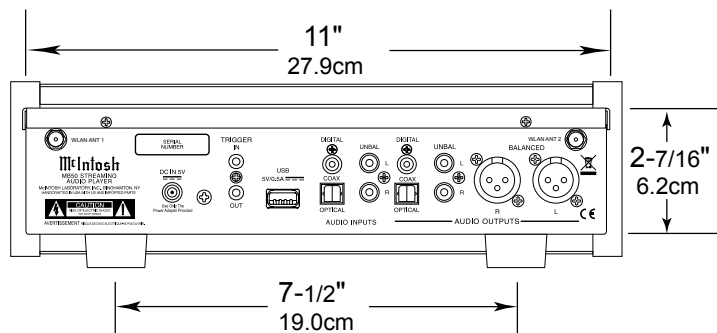

### Installation

The MB50 Streaming Audio Player is designed to be placed upright on a table or shelf, standing on its feet. The required ventilation requirements are shown. Always provide adequate ventilation for your MB50. Cool operation ensures the longest possible operating life for any electronic instrument. Do not install the MB50 directly above a heat generating device, such as a Power Amplifier. Allow at least 1 inch (2.5cm) above the top, 5/8 inch (1.6cm) below the bottom and 1 inch (2.5cm) on each side of the MB50, so that airflow is not obstructed. Allow 13-1/2 inches (34.3cm) of depth for airflow and cable connections.

MB50 Front View

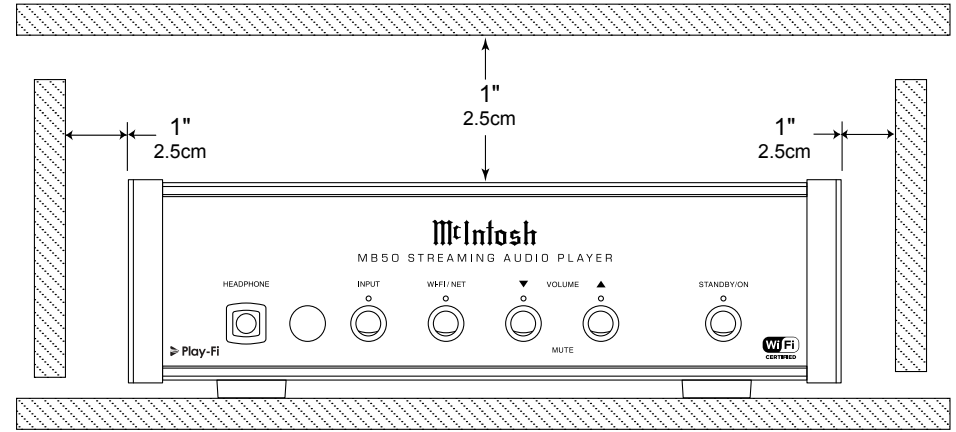

MB50 Side View

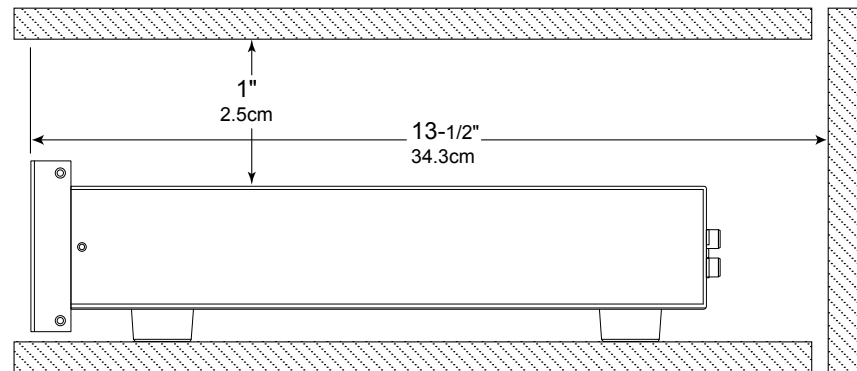



# Rear Panel Connections and AC/DC Adapter Connections

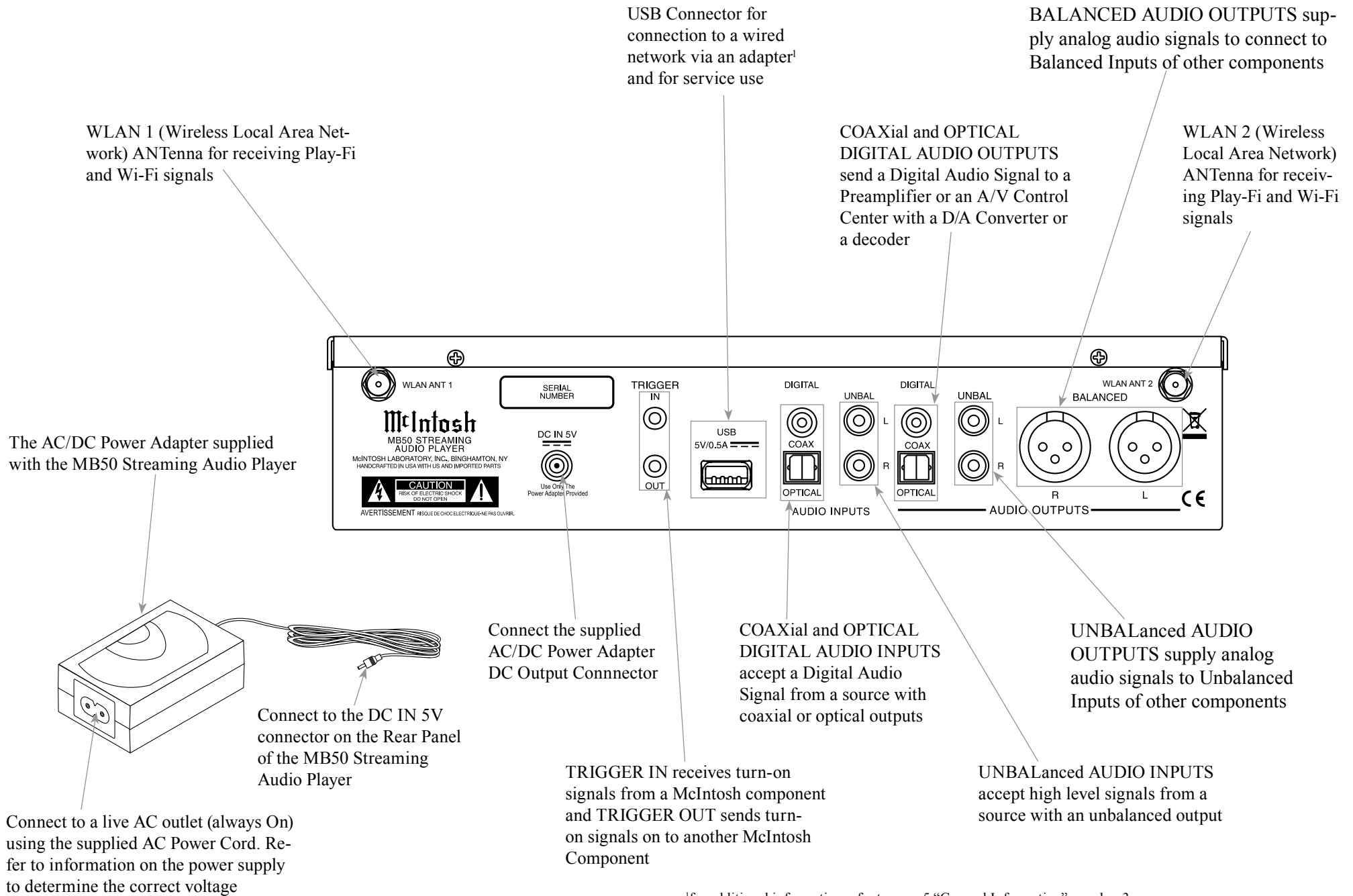

<sup>1</sup>for additional information refer to page 5 "General Information", number 3



## Connecting to a Preampifier or A/V Control Center

The MB50 has the ability to be remotely switched On/Off from a McIntosh Preampifier or A/V Control Center via the Trigger (Power Control) Connection.

The connection instructions below, together with the MB50 Connection Diagram located on the separate folded sheet “Mc1A”, is an example of a typical audio system. Your system may vary from this, however the actual components would be connected in a similar manner. For additional information refer to “Connector and Cable Information” on page 5.

### **Trigger (Power Control) Connections:**

1. Connect a Control Cable from the Preampifier or A/V Control Center Power Control MAIN (or ACC) Jack to the TRIGGER (Power Control) IN Jack on the McIntosh MB50 Streaming Audio Player.
2. Connect a Control Cable from the MB50 TRIGGER OUT Jack to the SACD/CD Transport Power Control IN.
3. Connect a Control Cable from the SACD/CD Power Control Out to the AM/FM Tuner Power Control In.
4. Connect a Control Cable from the AM/FM Tuner Power Control Out to the Media Bridge Server Power Control In.
5. Connect any additional components in a similar manner, as outlined in steps 2 thru 4.

### **Digital Audio Connections:**

6. Connect an Optical Cable from the McIntosh MB50 DIGITAL AUDIO OPTICAL INPUT to the Digital Audio Optical Output of the SACD/CD Player.
7. Connect a Coaxial Cable from the McIntosh MB50 DIGITAL AUDIO COAXIAL INPUT to the Digital Audio Coaxial Outputs of the Media Bridge Server.

### **Analog Audio Connections:**

8. Connect Cables from the McIntosh MB50 Streaming Audio Player AUDIO OUTPUT BALANCED Connectors to the Preampifier or A/V Control Center Balanced Input Connectors.

*Note: Unbalanced connections may be used instead of the Balanced Connections.*

9. Connect Cables from the McIntosh MB50 UNBALANCED AUDIO INPUT to the AM/FM Tuner Unbalanced Output.

### **Wired and Wireless Network Connections:**

10. Optionally, using an USB to Ethernet Adapter connect the MB50 USB Connector to the CAT 5/6 Ethernet Cable. Connect the other end of the CAT 5/6 Ethernet Cable to the Wired Router RJ45 Connector.
11. Connect another CAT 5/6 Ethernet Cable from the Wired Router to a Wireless Router.  
*Note: The Wireless Router facilitates communication and streaming from a mobile device to the MB50.*
12. When the MB50 will be utilizing direct communications with a Wireless Router (no wired Network Connections), make sure to connect the supplied WLAN Antennas to the WLAN ANT 1 and WLAN ANT 2 connectors on the MB50 Rear Panel.

### **AC Power Cords Connections:**

13. Locate the plug at the end of the cable coming out of the supplied AC/DC Power Supply and connect it to the DC IN 5V connector on the Rear Panel of the MB50 Streaming Audio Player.
14. Connect the supplied AC Power Cord between the socket on the AC/DC Power Supply and a live AC outlet (that is always On).



## Connecting to a Power Amplifier

The MB50 has the ability to provide a Trigger Output Signal to remotely switch the Power On/Off to components connected to it via the Trigger (Power Control) Connection.

The connection instructions below, together with the MB50 Connection Diagram located on the separate folded sheet “**Mc1B**”, is an example of a typical audio system. Your system may vary from this, however the actual components would be connected in a similar manner. For additional information refer to “Connector and Cable Information” on page 5.

### **Trigger (Power Control) Connections:**

1. Connect a Control Cable from the MB50 TRIGGER OUT Jack to the SACD/CD Transport Power Control IN.
2. Connect a Control Cable from the SACD/CD Power Control Out to the AM/FM Tuner Power Control In.
3. Connect a Control Cable from the AM/FM Tuner Power Control Out to the Media Bridge Server Power Control In.
4. Connect a Control Cable from the Media Bridge Server Power Control Out Jack to the Power Control In Jack on the Power Amplifier.
5. Connect any additional components in a similar manner, as outlined in steps 2 thru 4.

### **Digital Audio Connections:**

6. Connect an Optical Cable from the McIntosh MB50 DIGITAL AUDIO OPTICAL INPUT to the Digital Audio Optical Output of the SACD/CD Player.
7. Connect a Coaxial Cable from the McIntosh MB50 DIGITAL AUDIO COAXIAL INPUT to the Digital Audio Coaxial Outputs of the Media Bridge Server.

### **Analog Audio Connections:**

8. Connect Cables from the McIntosh MB50 Streaming Audio Player AUDIO OUTPUT, BALANCED Connectors to the Power Amplifier Balanced Input Connectors.

*Note: Unbalanced connections may be used instead of the Balanced Connections.*

9. Connect Cables from the McIntosh MB50 UNBALANCED AUDIO INPUT to the AM/FM Tuner Unbalanced Output.

### **Wired and Wireless Network Connections:**

10. Optionally, using an USB to Ethernet Adapter connect the MB50 USB Connector to the CAT 5/6 Ethernet Cable. Connect the other end of the CAT 5/6 Ethernet Cable to the Wired Router RJ45 Connector.
11. Connect another CAT 5/6 Ethernet Cable from the Wired Router to a Wireless Router.  
*Note: The Wireless Router facilitates communication and streaming from a mobile device to the MB50.*
12. When the MB50 will be utilizing direct communications with a Wireless Router (no wired Network Connections), make sure to connect the supplied WLAN Antennas to the WLAN ANT 1 and WLAN ANT 2 connectors on the MB50 Rear Panel.

### **AC Power Cords Connections:**

13. Locate the plug at the end of the cable coming out of the supplied AC/DC Power Supply and connect it to the DC IN 5V connector on the Rear Panel of the MB50 Streaming Audio Player.
14. Connect the supplied AC Power Cord between the socket on the AC/DC Power Supply and a live AC outlet (that is always On).



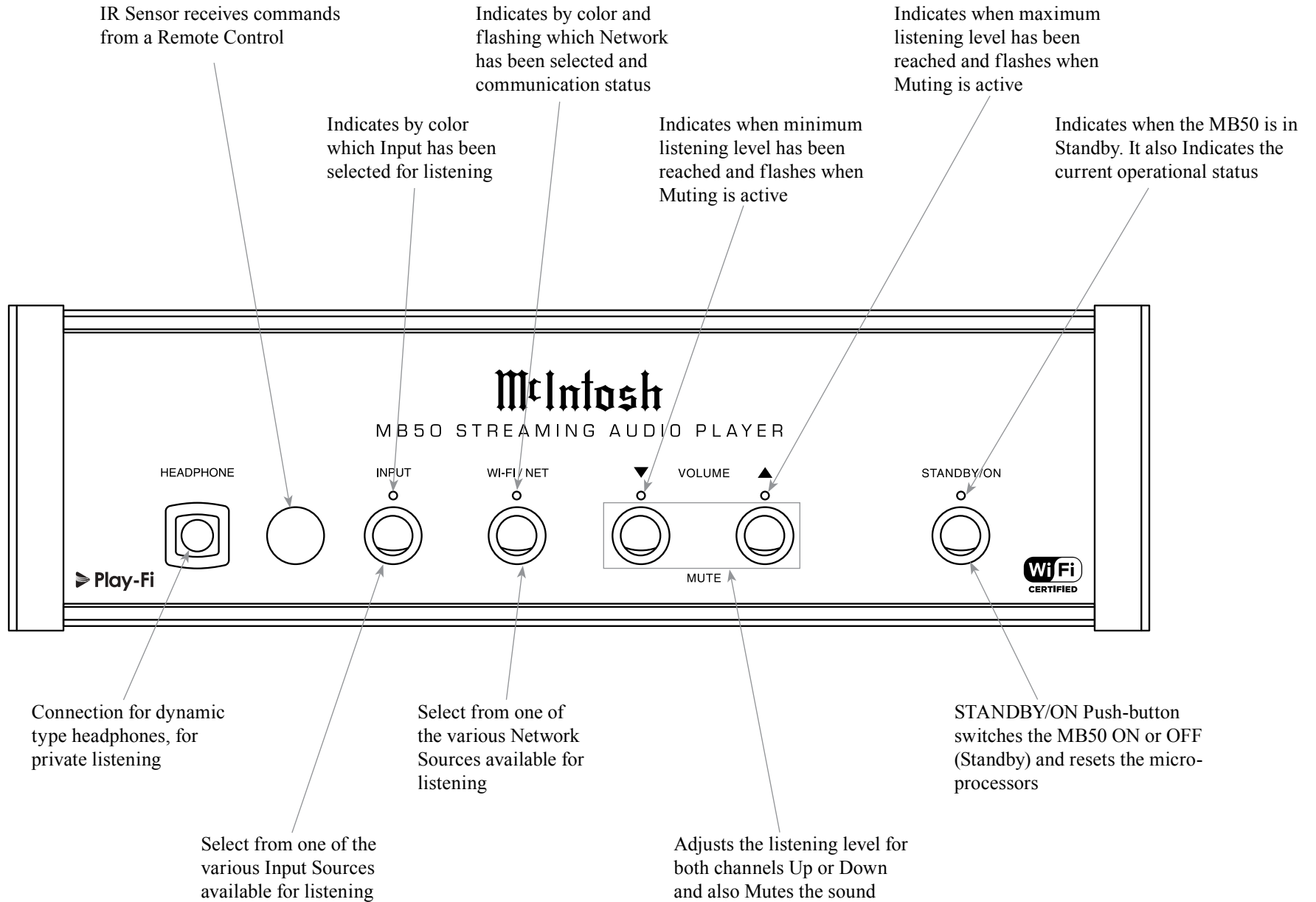

## How to use the Remote Control



The supplied Remote Control performs the various Operating Functions for the MB50 Streaming Audio Player.

- Notes:*
1. Refer to the “How to Operate” Section of this manual for additional information.
  2. The HR079 McIntosh Remote Control is also supplied with other McIntosh Products. If the MB50 is connected to a McIntosh Amplifier (also using the HR079) possible interaction can occur. To prevent interaction, Remote Control Operation of the MB50 can be switched Off. Refer to “Volume Level Note” on page 17 for additional information.

### Input Source Selection

Press the  Push-button to select the desired program source.

### Volume

Press the  or  Push-button to increase or decrease the listening level.

### Mute

Press the  (Mute) Push-button to mute the audio. The VOLUME LED indicators will flash at a slow rate during the time audio is muted. Press the MUTE Push-button a second time to resume listening.

### Pause

Press the PAUSE  Push-button to temporarily stop playback of the music.

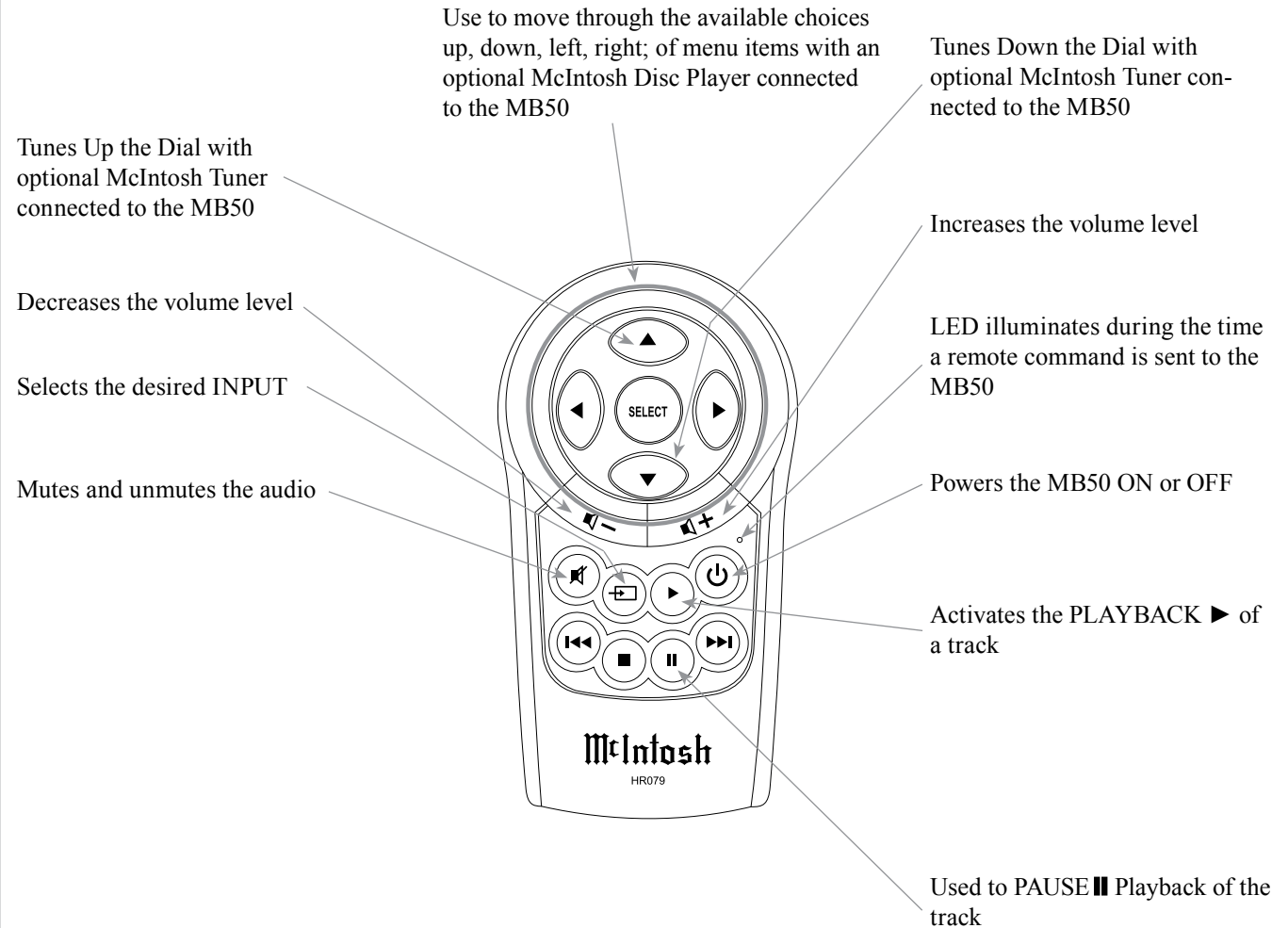

*Note: Push-buttons whose function is not identified above are for use with other McIntosh Products.*



## Introduction to Setting Up the MB50

Your McIntosh MB50 is factory configured for immediate enjoyment of superb audio from source components with Digital or Analog Outputs.

It is highly recommended to contact your McIntosh Dealer and/or Mobile Device Dealer for assistance

in the installation and configuration of the Wireless Router and/or the wired network with a Wireless Router. Your Dealer has the necessary knowledge to properly set up the MB50 as part of your Home Network wired or wireless.

To utilize the MB50 Play-Fi feature (for streaming music from your mobile device), it is necessary to first establish Wi-Fi (wireless) communications between the MB50 and the mobile device.

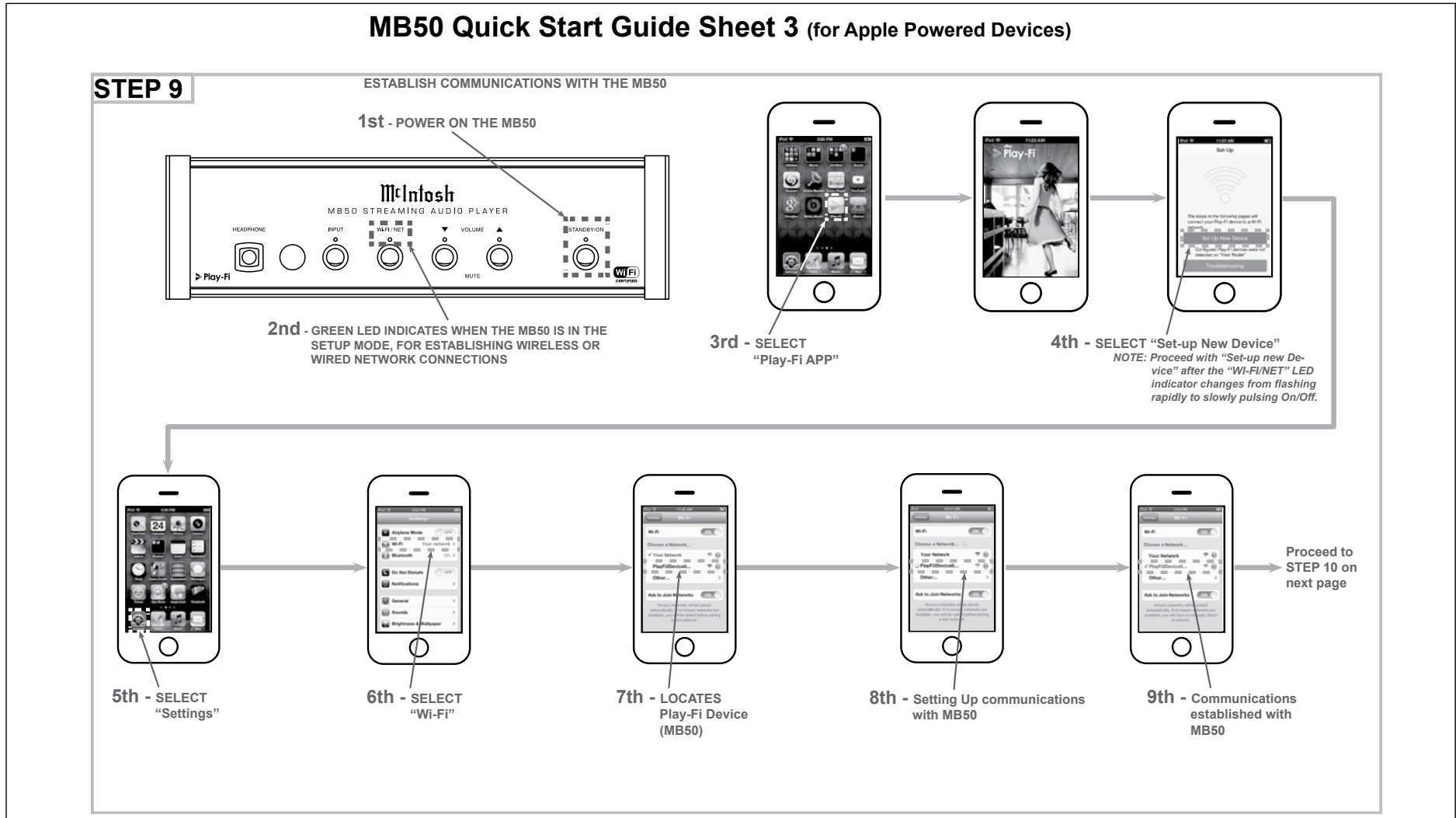

Figure 1

The MB50 Quick Start Guide (located on the supplied separate folded sheets) will aid in establishing the communications between the MB50, your Mobile Device and the Network/Wireless Router. Figures 1

and 2 are sample illustrations from the MB50 Quick Start Guide for Apple and Android Powered Mobile Devices. After communications have been established, proceed to page 16 “How to Operate the MB50”.

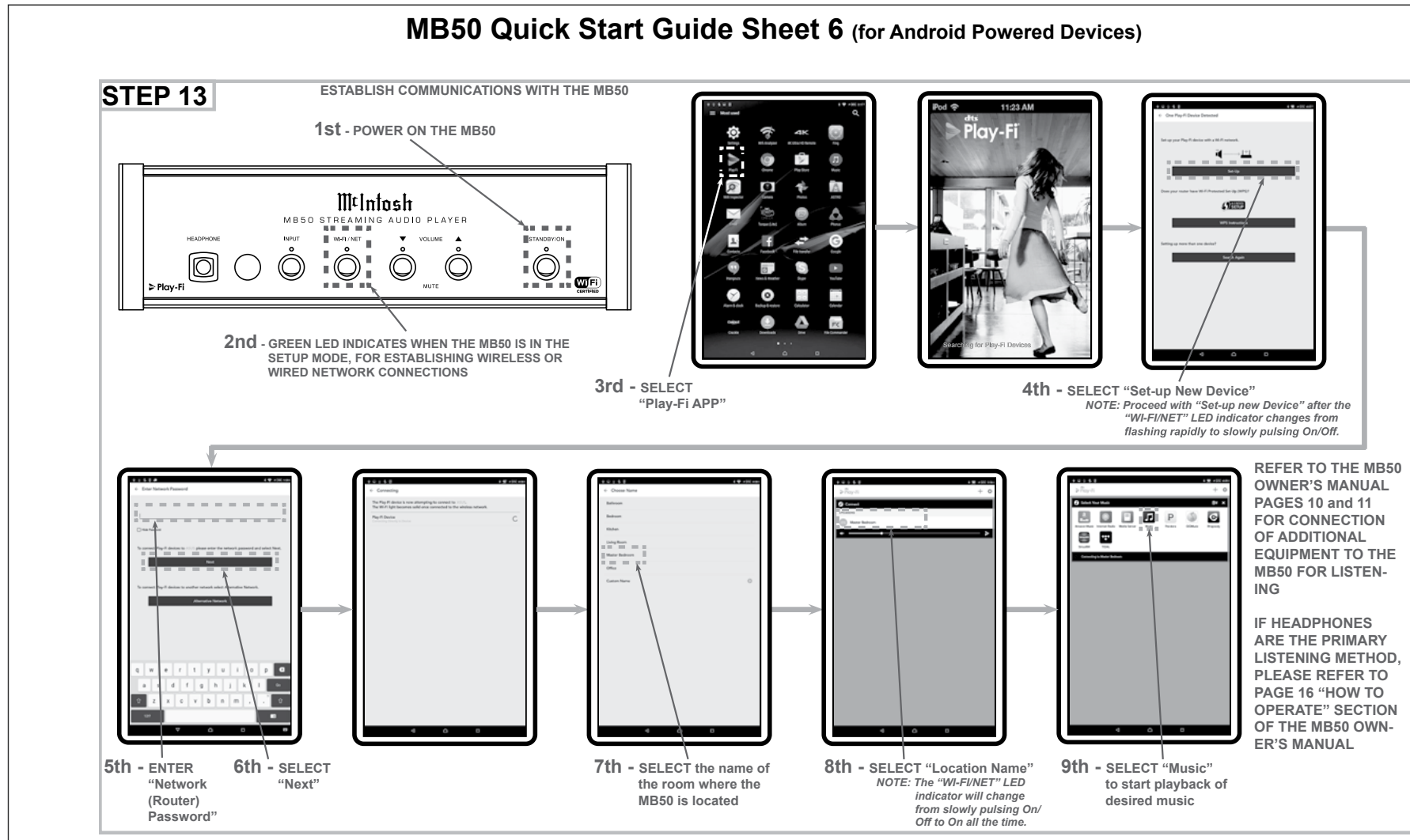

Figure 2





## How to Operate the MB50

Your McIntosh MB50 is factory configured for immediate enjoyment of superb audio from a Mobile Device via Play-Fi or one of the external devices connected to the Rear Panel of the MB50.

If you wish to make a Play-Fi wireless connection between the Mobile Device and the MB50, please refer to “Introduction to Setting Up the MB50” on page 14 for additional information.

### Power On

Press the ON/STANDBY Push-button on the Front Panel of the MB50 or press the  Power Push-button on the Remote Control to switch On the MB50. Refer to figures 30 and 31.

FRONT PANEL STANDBY/ON INDICATOR			
MB50 On/Off	Color of LED	Operation Status	Network Connection Status
Off	Red	Standby Mode	Not connected
Off	Orange	Sleep Mode	Maintains Connection
On	Green	On Mode	Connection if established

### Power Mode

The MB50 incorporates an Auto Off Feature, which automatically places it into the Power Save Mode. This

occurs approximately 2 hours after there has been an absence of audible audio signals on the selected input or user activity (includes changes to any of the Operation Functions such as Input selection, Volume adjustment, etc). It also allows for choosing between if the Network Connection (Sleep Mode) is maintained or the Network Connection (Standby Mode) becomes active thus terminating the Network Connection. If it is desired to enable the Auto Off Feature perform either of the following:

#### Auto Off with Network Sleep Mode Disabled:

1. Press and hold simultaneously the Wi-Fi/NET and VOLUME ▼ (Down) Push-buttons until the Front Panel Display Wi-Fi/NET LED Indicator changes color from Green to Red. Then release the two Push-buttons. The Power Save Mode is now Disabled.
2. To Enable the Power Save Mode repeat step 1 and the Wi-Fi/NET LED Indicator will change color from Red to Green.

#### Auto Off with Network Standby Mode Enabled:

1. Press and hold simultaneously the STANDBY/ON and VOLUME ▲ (Up) Push-buttons until the

Front Panel Display Wi-Fi/NET LED Indicator changes color from Green to Red. Then release the two Push-buttons. The Power Save Mode is now Disabled.

2. To Enable the Power Save Mode repeat step 1 and the Wi-Fi/NET LED Indicator will change color from Red to Green.

### Network Sleep Mode

The Network Sleep Mode is Enabled by default. With the Sleep Mode active, the MB50 will automatically switch On when the Mobile Device Play-Fi App is started and the assigned name (for the MB50) is selected. When the MB50 is connected to AC Power for the first time (or if a Reset to Factory Default Settings is performed) its operational status is “Standby Mode”. After switching AC Power first On to the MB50 the Operation Status will automatically change to the “Sleep Mode” when it is switched Off. To place the MB50 in Standby Mode for just the current time (Sleep Mode Disabled), perform the following step:

1. With the MB50 On, press and hold the STANDBY/ON Push-buttons until the Front Panel STANDBY/ON LED Indicator changes color from Green to a flashing Red. Then release the STANDBY/ON Push-button. When the MB50 has completed the change, the MB50 will switch Off and the Front Panel STANDBY/ON LED Indicator color is a constant Red. The MB50 is now in the Standby Mode.

The next time the MB50 is switched On the Network Sleep Mode will automatically re-activate.

### Source Selection

To select the desired audio source, press the INPUT Push-button on the Front Panel of the MB50 or press



Figure 30

the  (Input) Push-button on the Remote Control until the desired source is selected. Refer to figures 30 and 31.

MB50 Inputs	
Music Source	Indicator Color
Wi-Fi - Play-Fi Mobile Device	Green
NET - Play-Fi over the Network	
COAX - Digital coaxial connection to an external source	Red
OPTICAL - Digital optical connection to an external source	White
UNBAL - Analog stereo connection to an external source	Blue

*Note: The Mobile Device will disconnect when switching to another Input Source on the MB50.*

### Volume Level

To increase the Volume Level, press the Front Panel VOLUME ▲ (Up) Push-button or the VOLUME  + Push-button on the Remote Control to increase the volume to the desired level. The LED indicator above the Front Panel VOLUME ▲ (Up) Push-button will illuminate continuously during the increase of Volume Level. When the maximum volume level is reached, the LED will flash rapidly.

To decrease the Volume Level press the Front Panel VOLUME ▼ (Down) Push-button or the VOLUME  - Push-button on the Remote Control. The LED indicator above the Front Panel VOLUME ▼ (Down) will illuminate continuously during the decrease of Volume Level. When the minimum volume level is reached the LED will flash rapidly. Refer to figure 30 and 31.

*Note: When the MB50 is connected to an existing Audio System (or Audio/Video System) with a Preamplifier, it may be desirable to use the System Volume Control to adjust the listening volume level when*



*the MB50 is the selected music source. To change the MB50 from a variable output volume to a fixed output volume level, perform the following steps:*

1. Select the desired MB50 Music Source.
2. Using the MB50 Volume Push-buttons adjust the listening level to be at the same relative listening level as when other inputs on the Audio System (or Audio/Video System) are selected.
3. Using the Front Panel INPUT and VOLUME ▼ (Down) Push-buttons, press and hold them in until the Illumination of the Front Panel nomenclature switches Off, then release both Push-buttons.
4. The MB50 Output Volume Level is now fixed, Remote Control Operation of the MB50 is switched Off and Input Source Selection is now performed by using the Front Panel INPUT Push-button.

*To return the MB50 to a variable VOLUME adjustment of the listening level and to reactivate Remote Control Operation, repeat step 3.*

### Mute

To mute the volume level, simultaneously press the VOLUME ▼(Down) and ▲(Up) Push-buttons on the Front Panel of the MB50 or press the  Mute Push-button on the Remote Control. Dur-

ing the time the sound is muted the Volume LEDs on the Front Panel will flash at a slow rate. To unmute and return to the previous volume level, simultaneously press the VOLUME ▼(Down) and ▲(Up) Push-buttons on the Front panel or press the  Mute Push-button on the Remote Control. Pressing either the VOLUME ▼(Down) or ▲(Up) Push-button on the Front Panel or the VOLUME  - or  + on the Remote Control will also un-Mute the MB50. Refer to figure 30 and 31.

### Play-Fi

For Mobile Device specific operating information (Apple or Andriod) go to the Play-Fi web site at <https://play-fi.com/>

- Notes:*
1. If you have questions about the Play-Fi App and its Operation refer to the Play-Fi “Knowledge Base” for additional information.
  2. Some of the Internet Music Streaming Services (available via the Play-Fi App) offer the listener the ability to alter the sound quality of music being streamed. Refer to each of the Music Streaming Services Internet Web Site for additional information on how to make changes to their default settings, if available.

### Critical Listening Mode

The Play-Fi App supports the native sound resolution formats of the music played. When the sound format is high resolution, the sound is normally down-sampled to insure proper Wi-Fi Streaming Capability with the most common wireless network hardware. In the Play-Fi App there is a Critical Listening Mode which keeps the original sound resolution up to 96kHz/24Bit. This requires the MB50 and Mobile Device be connected by high performance network equipment. To activate the Critical Listening Mode perform the following

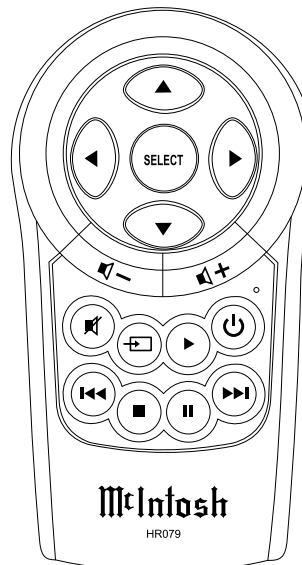

Figure 31

steps using the Play-Fi App:

1. Select the “Hi RES Audio” Icon. Refer to figure 32.

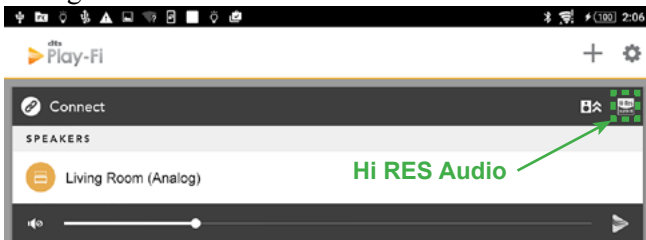

Figure 32

2. Referring to figure 33, select the MB50 (in this example it is the “Living Room”).

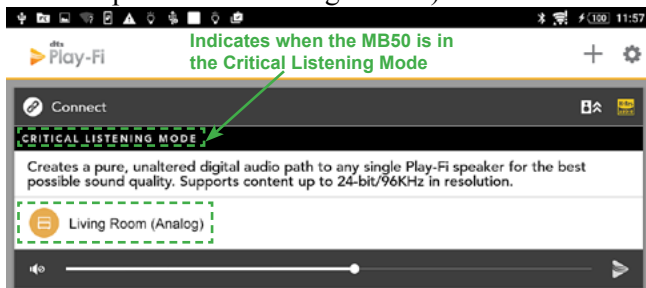

Figure 33

3. Select “Music”. Refer to figure 34.

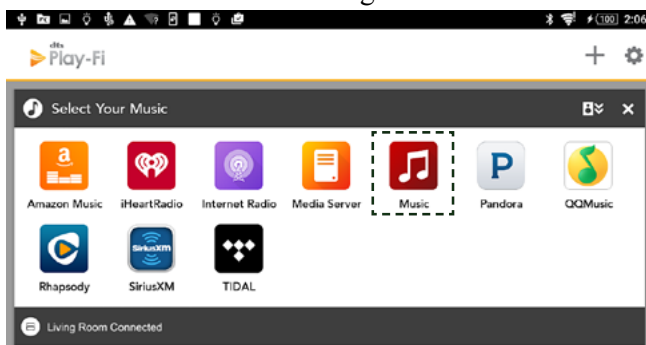

Figure 34

*Note: When a recording is in a sound format not supported by the Critical Listening Mode, a message will appear stating “This file is encoded in an unsupported sample rate and cannot be played”. Refer to figure 35*

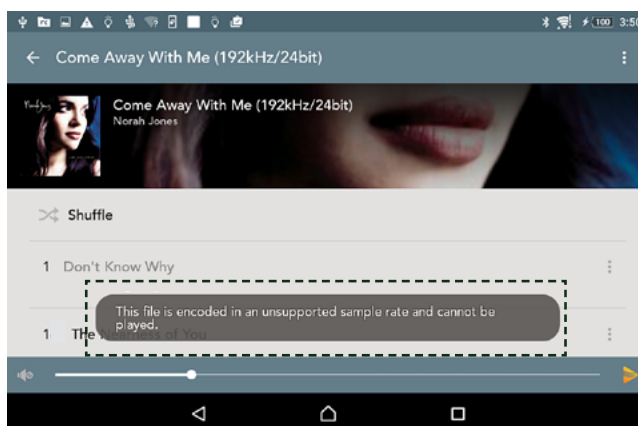

Figure 35

4. The music selection that has the unsupported sample rate may be listened to by switching Off the Critical Listening Mode. Switch Off the Critical Listening Mode by first selecting the “X”. Refer to figure 36. Then select “OK” in the “Are you sure? Closing will stop playback” window.

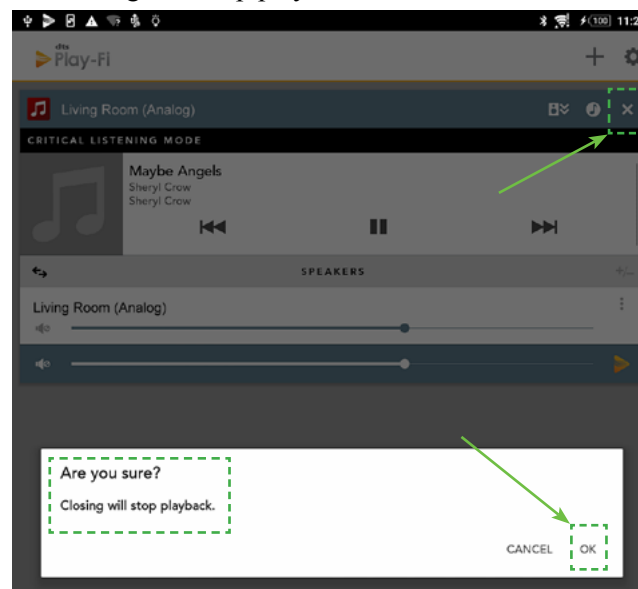

Figure 36

5. Then select the MB50 (Living Room) followed by selecting “Music”. Refer to figures 37 and 38.

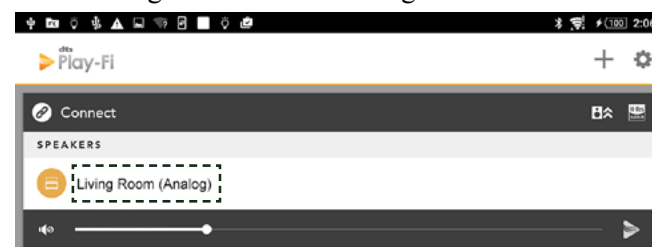

Figure 37

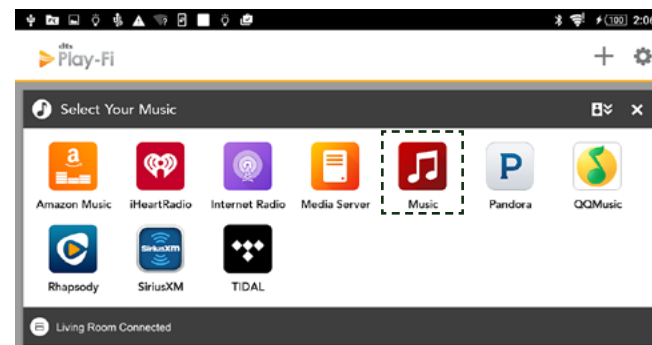

Figure 38

7. Then select the music. Refer to figure 39.

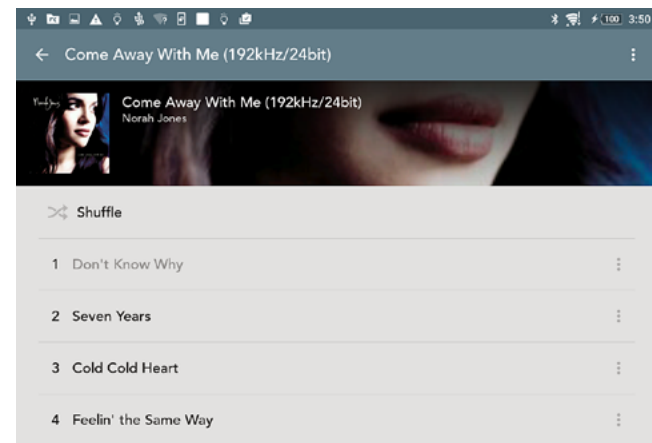

Figure 39

**Line In Streaming Mode**

The MB50 has the ability to stream the audio from the selected Audio Input (Digital or Analog) via the Play-Fi App to Wireless Loudspeaker Systems, such as the McIntosh RS100, located in another room. In the following example the MB50 is located in the living room and in the bedroom a pair of Wireless Powered Loudspeakers (like the McIntosh RS100). To activate the Line In Streaming Mode perform the following steps:

*Note: Before proceeding below, it is first important to setup the Wireless Loudspeakers using the Play-Fi App either as a single Loudspeaker or as a Stereo pair. Refer to the information supplied with the Wireless Loudspeaker(s).*

1. Start the Play-Fi App on the Mobile Device and select the “Plus Symbol”. Refer to figure 40.

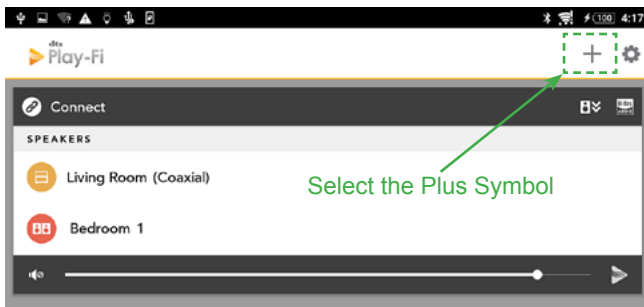

Figure 40

2. From the plus menu, select “Line In”. Refer to figure 41.



Figure 41

3. Then select the MB50 (Living Room) in the Line In Window. Refer to figure 42.

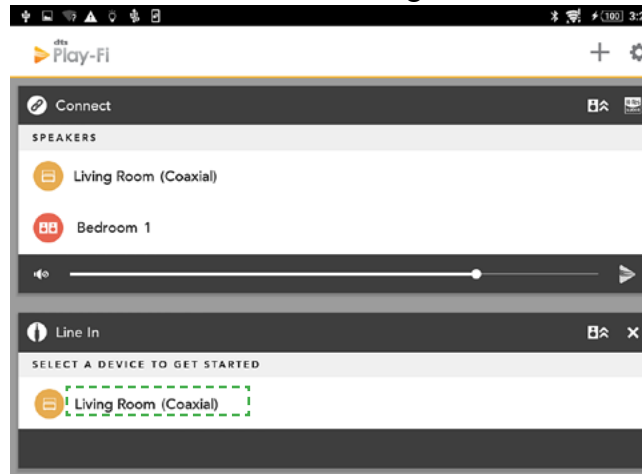

Figure 42

4. Now select the Audio Source Coaxial Input to be streamed to the Wireless Loudspeakers located in Bedroom 1. Then select “NEXT”. Refer to figure 43.

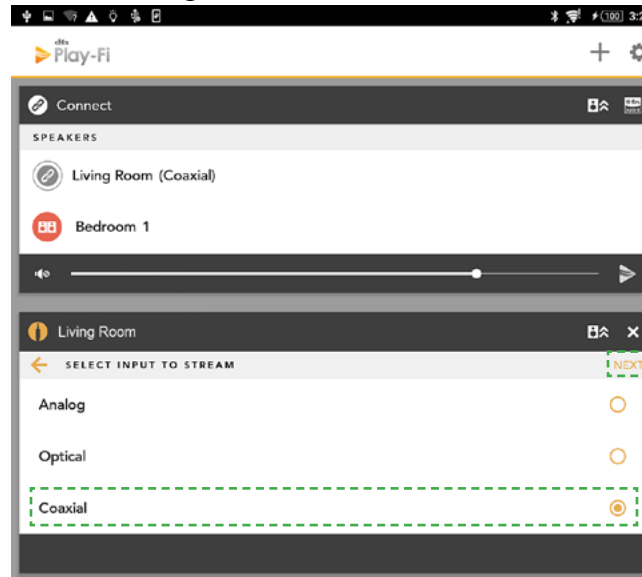

Figure 43

5. The just selected Input (Coaxial) can now be streamed to the Wireless Loudspeakers (Bedroom 1) and can also be listened to in the Living Room (via the MB50). Referring to figure 44 make the appropriate room selections followed by selecting “DONE”.

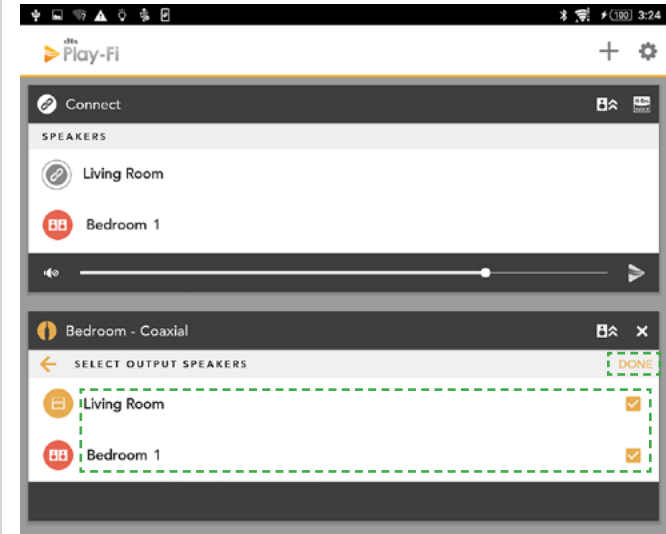

Figure 44

6. The selected Input (Coaxial) will now be playing in both rooms (Living Room and Bedroom 1). There are three Volume Control Adjustments available, Living Room, Bedroom 1 and a Master Volume affecting both rooms at the same time. Refer to figure 45 on the next page.

## Line In Streaming Mode, con't

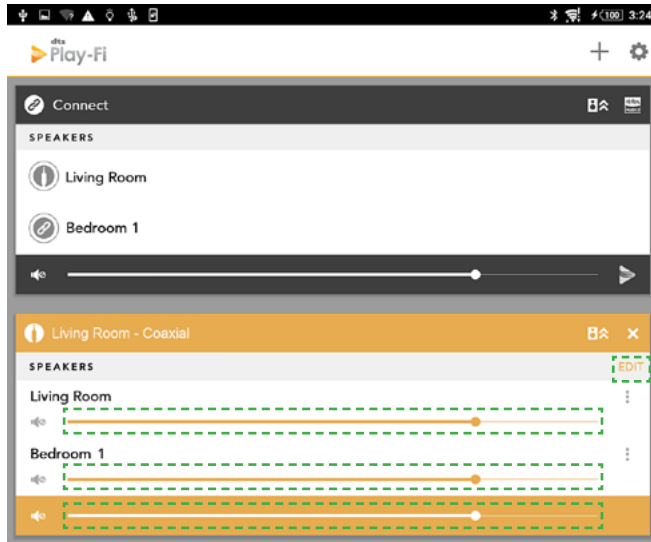

Figure 45

- Referring to figure 46, the selection of the Streaming Source, and what room(s) will be playing that source may be changed at any time by selecting “EDIT”. The first choice will be to either keep the same source or select another source. Then select “NEXT” to decide on the room(s) that will playing music.

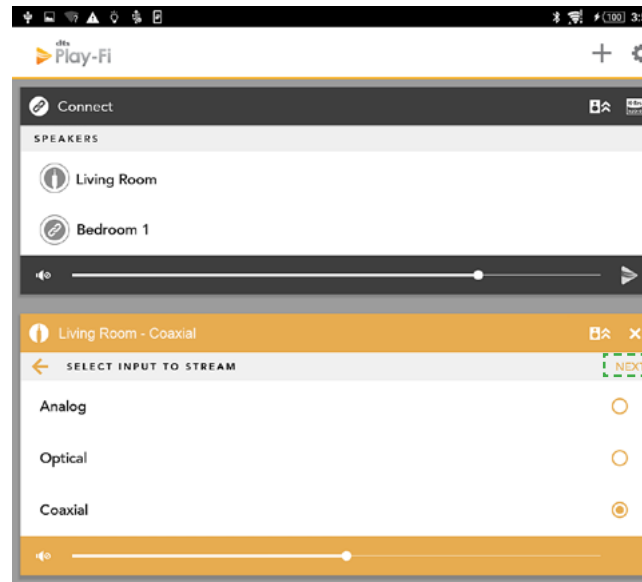

Figure 46

## Resetting to Factory Default Settings

If it becomes desirable to reset all of the MB50 settings to the factory default values, perform the following steps:

- With the MB50 On, press and hold in simultaneously the INPUT and STANDBY/ON Push-buttons.
- Release the Push-buttons when the Front Panel LEDs start flashing.
- Press the STANDBY/ON Push-button and refer to page 14 to re-establish communications with your Mobile Device.







### Audio Specifications

#### Frequency Response

+/-0.5dB from 20Hz to 20,000Hz

#### Total Harmonic Distortion

0.005%

#### Sensitivity

200mV, UnBalanced

#### Maximum Input Signal

2Vrms, UnBalanced

#### Variable Output level

0 - 6.0Vrms Unbalanced

0- 12.0Vrms Balanced

#### Signal To Noise Ratio (A-Weighted)

100dB

#### Dynamic Range

98dB

#### Output Impedance

Less than 200 ohms (Unbalanced and Balanced)

### Digital Audio Specifications

#### Digital Input Signal Format

Coaxial and Optical Inputs - SPDIF (PCM<sup>1</sup>)

#### Digital Input Sample Rate

Coaxial and Optical: 44.1kHz to 192kHz, 24-Bit

#### Digital Inputs

Coaxial: 0.5V p-p/75 ohms

Optical: - 15dbm to -21dbm (TOS Link)

<sup>1</sup> PCM (Pulse Code Modulation) Digital Signal type used for CD Discs, etc.

### Power Control Specifications

#### Power Control Input

5-15VDC, less than 1mA

#### Power Control Output

12VDC, 25mA maximum total

### USB Connector

Type A connector with Host Mode.

Used for firmware Updates and Network Connection using a special adapter (see page 5, note 3 for additional information)

### Wi-Fi Connectivity

IEEE 802.11a/b/g/n ; Wi-Fi (Dual Band).WPS

### General Specifications

#### Power Requirements

100-240 Volts, 50/60Hz at 10 Watts

Standby: Less than 0.5 watt

#### Overall Dimensions

Width is 11-1/2 inches (29.2cm)

Height is 3-25/32 inches (9.6cm)

Depth is 15-1/2 inches (39.4cm) including the Front Panel and connection cables.

#### Weight

8.5 pounds (3.9Kg) net (includes the external Power Supply), 9.5 pounds (4.3Kg) in shipping carton

#### Shipping Carton Dimensions

Width is 16 inches (40.6cm)

Height is 9 inches (22.8cm)

Depth is 17 inches (43.1cm)



## Packing Instructions

In the event it is necessary to repack the equipment for shipment, the equipment must be packed exactly as shown below. It is very important that the four plastic feet are attached to the bottom of the equipment. This will ensure the proper equipment location on the bottom pad. Failure to do this will result in shipping damage.

Use the original shipping carton and interior parts only if they are all in good serviceable condition. If a shipping carton or any of the interior part(s) are needed, please call or write Customer Service Department of McIntosh Laboratory. Refer to page 4. Please see the Part List for the correct part numbers.

Quantity	Part Number	Description
1	034565	Shipping carton only
2	034566	Side Foam Pad
4	163185	Plastic foot
4	400159	#10-32 x 3/4" screw
4	404080	#10 Flat washer

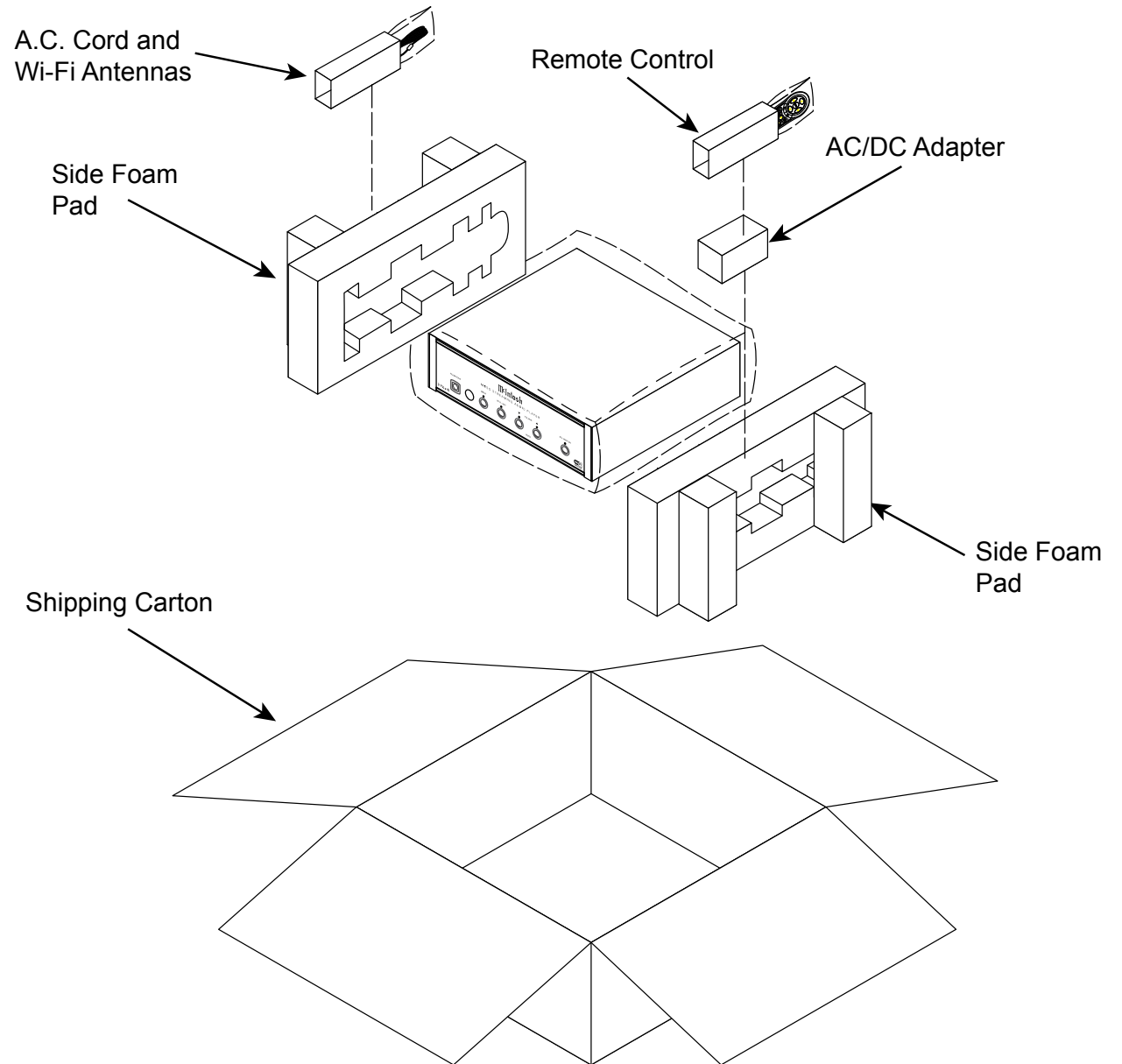



McIntosh Laboratory, Inc.  
2 Chambers Street  
Binghamton, NY 13903  
[www.mcintoshlabs.com](http://www.mcintoshlabs.com)

The continuous improvement of its products is the policy of McIntosh Laboratory Incorporated who reserve the right to improve design without notice.

The MB50 is designed to employ non-McIntosh-provided services (including but not limited to Play-Fi® and Wi-Fi®), some of which require separate customer subscriptions and some of which do not, as part of the Products' functionality. Because McIntosh cannot control the providers of such services or the services themselves, the owner of the Product therefore assumes all risks related to the use of services provided by anyone other than McIntosh itself. McIntosh cannot and does not warrant against, and shall have no liability of any kind for any of the following that are attributable to non-McIntosh providers or services: (i) interruption, discontinuance, or other unsatisfactory performance of service; (ii) reduced Product functionality that is so attributable; or (iii) any other loss or damage of any kind that is so attributable.