



McIntosh Laboratory, Inc. 2 Chambers Street Binghamton, New York 13903-2699 Phone: 607-723-3512 [www.mcintoshlabs.com](http://www.mcintoshlabs.com)

# MCD85

SACD/CD Player

Owner's Manual



The lightning flash with arrowhead, within an equilateral triangle, is intended to alert the user to the presence of uninsulated “dangerous voltage” within the product’s enclosure that may be of sufficient magnitude to constitute a risk of electric shock to persons.

**WARNING - TO REDUCE RISK OF FIRE OR ELECTRICAL SHOCK, DO NOT EXPOSE THIS EQUIPMENT TO RAIN OR MOISTURE.**

**Additional Safety Information is supplied in a separate document “Important Additional Operation Information Guide”**



**ATTENTION:**  
RISQUE DE CHOC ELECTRIQUE - NE PAS OUVRIR

**NO USER-SERVICEABLE PARTS INSIDE. REFER SERVICING TO QUALIFIED PERSONNEL.**

The exclamation point within an equilateral triangle is intended to alert the user to the presence of important operating and maintenance (servicing) instructions in the literature accompanying the appliance.

**To prevent the risk of electric shock, do not remove cover or back. No user-serviceable parts inside.**

**CAUTION:** Invisible Laser Radiation when open. **DO NOT** stare into the beam or view directly with optical instruments. Use of controls or adjustments or performance of procedures other than those specified in the Owners Manual may result in Hazardous Radiation Exposure.

**ATTENTION:** Rayonnement Laser Invisible en cas d’ouverture. Ne pas regarder dans le faisceau ni observer directement à l’aide d’instruments d’optiques. L’utilisation de commandes, de réglages ou d’instructions autres que ceux spécifiés dans le manuel du propriétaire peut entraîner une exposition x à des rayonnements dangereux

This product incorporates an embedded **CLASS 3R Laser (IEC60825-1).**

**LUOKAN 1 LASERLAITE  
KLASS 1 LASER APPARAT**

**VAROITUS!** Laitteen käyttäminen muulla kuin tassa käyttöohjeessa mainitulla tavalla saattaa altistaa käyttäjän turvallisuusluokan 1 ylittävälle näkymättömälle lasersäteilylle.

**VARNING!** Om apparaten används på annat sätt än denna bruksanvisning specificerats, kan användaren utsättas för osynlig laserstrålning, som överskrider gränsen för laserklass 1.

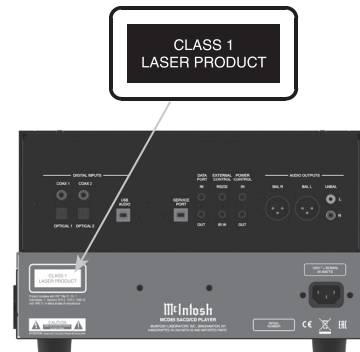

**CAUTION:** CLASS 3R INVISIBLE LASER RADIATION WHEN OPEN. DO NOT STARE INTO THE BEAM OR VIEW DIRECTLY WITH OPTICAL INSTRUMENTS. AVOID DIRECT EYE EXPOSURE.  
**ATTENTION:** RAYONNEMENT LASER INVISIBLE DE CLASSE 3R EN CAS D’OUVERTURE. NE PAS REGARDER DANS LE FAISCEAU NI OBSERVER DIRECTEMENT À L’AIDE D’INSTRUMENTS D’OPTIQUE. EXPOSITION DIRECTE DANGEREUSE DES YEUX.

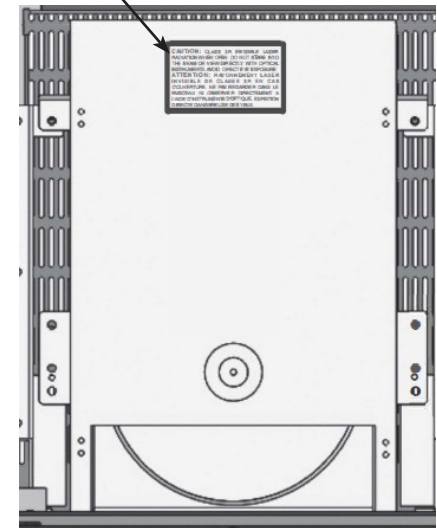

Interior view

**The MCD85 SACD/CD Player marries McIntosh’s long tradition of uncompromising quality with the latest cutting edge innovations to bring you an unsurpassed luxury sonic experience.**

---

## Thank you from all of us at McIntosh

---

With the MCD85 SACD/CD Player, you have invested in a precision instrument that will provide you with many years of enjoyment. Please take a few moments to familiarize yourself with the features and instructions to get the maximum performance from your equipment.

If you need further technical assistance, please contact your dealer who may be more familiar with your particular setup including other brands. You can also contact McIntosh with additional questions or in the unlikely event of needing service.

**McIntosh Laboratory, Inc.**  
 2 Chambers Street  
 Binghamton, New York 13903

Technical Assistance: (607) 723-3512  
 Customer Service: (607) 723-3515  
 Fax: (607) 724-0549  
 Email: support@mcintoshlabs.com  
 Website: mcintoshlabs.com

---

## Make a Note

---

For future reference, you can jot down your serial number and purchase information here. We can identify your purchase from this information if the occasion should arise.

Serial Number:	
Purchase Date:	
Dealer Name	

---

## Safety First

---

**Important Safety Information is supplied in a separate document “Important Additional Operation Information Guide”**

## Table of Contents

Thank you from all of us at McIntosh .....	3
Make a Note .....	3
Safety First.....	3
Where to put it .....	4
The Front Panel.....	5
The Left Knob .....	5
The Right Knob .....	5
Connections on the Back .....	6
The Inputs .....	6
The Outputs .....	6
Making Connections.....	6
Balanced/XLR Output.....	6
Unbalanced RCA/Phono Output.....	7
RS232.....	7
Wired IR Input.....	7
Power Control (Trigger) Output.....	7
Connection Diagram.....	8
Data Ports .....	9
Optical.....	9
Coax.....	9
Power On the MCD85.....	10
Setup Menu .....	10
IR Code.....	10
Data Setup.....	11
Play a Disc .....	11
Navigating CD-ROMs .....	11
Vacuum Fluorescent Display (VFD) .....	12
Remote Control Buttons .....	13
Changing the Remote Control’s Battery .....	14
Specifications .....	14
Resetting the Microprocessor .....	15
Packing the MCD85.....	15



## Where to put it

The MCD85 can be placed upright on a table or shelf, standing on its four feet. It also can be custom installed in a piece of furniture or cabinet.

Always provide adequate ventilation for your MCD85. Cool operation ensures the longest possible operating life for any electronic instrument. Do not install the MCD85 directly above a heat generating

component such as a high-powered amplifier. If all the components are installed in a single cabinet, a quiet running ventilation fan can be a definite asset in maintaining all the system components at the coolest possible operating temperature.

A custom cabinet installation should provide the following minimum spacing dimensions for cool operation ( Figure 02):

- 6 inches (15.3cm) above the top
- 5/8 inches (1.6cm) below the bottom

- 2 inches (5.1cm) on each side of the MCD85 so that airflow is not obstructed
- 18 inches (45.7cm) depth behind the front panel
- 1-7/16 inch (3.7cm) in front of the mounting panel for knob clearance

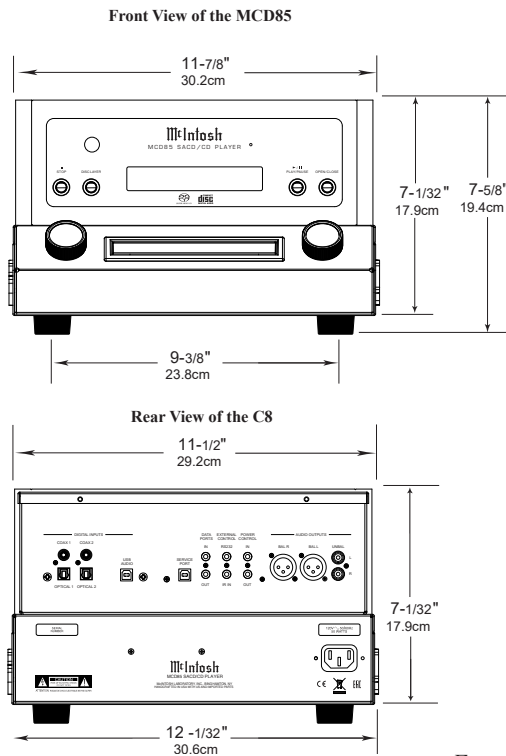

Figure 01– MCD85 Dimensions

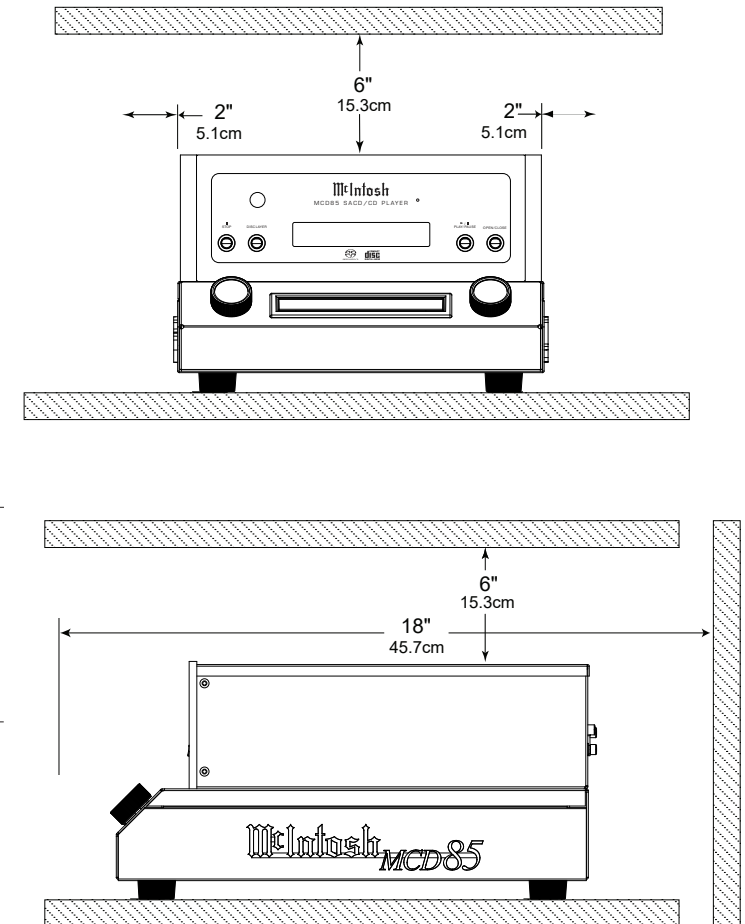

Figure 02– Ventilation requirements

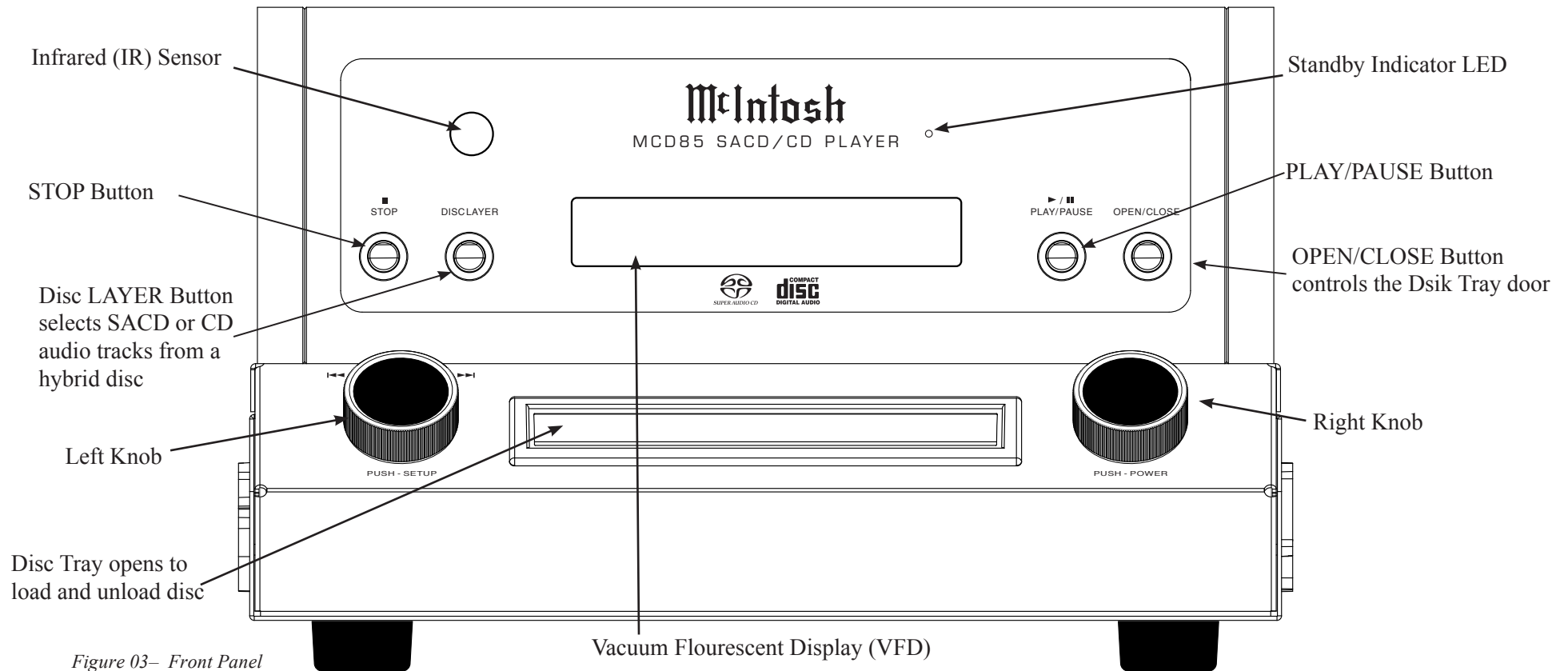

Figure 03– Front Panel

## The Front Panel

The MCD85's glass and metal Front Panel provides two control knobs, four buttons and an informational display (VFD).

### The Left Knob

The Left Knob, labeled BACK and NEXT on above the Knob and PUSH-SETUP below.

Push and release the Left Knob to enter the Setup Menu. Rotating the Left Knob will scroll through the Setup menu options.

When listening to the CD Player, rotating the Left

Knob Clockwise will advance to the next tracks. A counterclockwise turn will go to previous tracks.

### The Right Knob

The Right Knob is labeled INPUT above the Knob and PUSH POWER below.

Push and release the Right Knob to Power On or Off. The **Standby Indicator LED** will glow red as long as AC Power is connected to the MCD85. Rotating the Right Knob will scroll through the available Inputs. Stop turning when a desired Input is reached.

## The Buttons

STOP, Disc LAYER, PLAY/PAUSE and OPEN/CLOSE are used to operate the CD PLAYER as seen in Figure 03.

The Disc LAYER button toggles between CD, STEREO (SACD), and MULTI (SACD). Push and release until you stop on the mode you want. Typically, either CD or Stereo. Stereo will play in SACD mode if supported on that disc. A regular CD will play as a regular CD in STEREO mode. Choosing MULTI will result in no sound because there is no multichannel processing. The MCD85 is a stereo SACD/CD player.



Figure 04– MCD85 Rear View

## Connections on the Back

### The Inputs

- Two Digital Coax Inputs
- Two Digital Optical Inputs
- One USB Audio Input
- One 1/8-inch jack for RS232 connector
- One 1/8-inch jack for wired IR Input
- One AC power connector
- One USB upgrade service port
- One 1/8-inch Data Input jack (IN)
- One 1/8-inch Power Control (trigger) Input (IN)

### The Outputs

- One Pair unbalanced RCA Output
- One pair balanced XLR audio Output
- One 1/8-inch Data Output jack (OUT)
- One 1/8-inch Power Control (trigger) Output (OUT)

## Making Connections

### Balanced/XLR Output

The Balanced Output (BAL L and BAL R) allows the MCD85 to be connected to a Balanced Input (typically a preamplifier). To use the XLR output, connect the BAL R to the right input of your preamplifier and BAL L to the preamplifier's left input.

Below is the Pin configuration for the XLR Balanced Input and Output Connectors on the MCD85.

- PIN 1: Shield/Ground
- PIN 2: + Signal
- PIN 3: - Signal

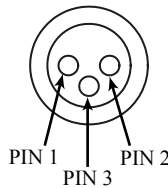

Figure 05– XLR pin diagram

## Unbalanced RCA/Phono Output

The Unbalanced Output (UNBAL L and R) allows the MCD85 to be connected to an input, typically of a preamplifier, using RCA/ Phono cables. The top white jack is left (L) and the lower red jack is right (R).

## RS232

The RS232 jack is used to connect the MCD85 to automation controller devices with RS232 connectors. To utilize this feature, you will need an appropriate RS232 Data Cable. The RS232 Data Cable should be an 1/8 inch (3.5mm) stereo mini phone plug to a subminiature DB9 connector.

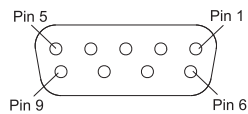

Figure 07– DB9 connector pin layout

### RS232 DB9 Connector Pin Layout

- |                        |        |
|------------------------|--------|
| 1. N/C (no connection) | 6. N/C |
| 2. Data In (RXD)       | 7. N/C |
| 3. Data Out (TXD)      | 8. N/C |
| 4. N/C                 | 9. N/C |
| 5. Gnd                 |        |

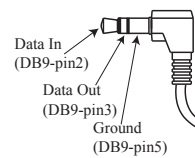

Figure 06– Mini plug for RS232 connection

Typical RS232 settings are:

- 8 data bits, no parity and one stop bit
  - Baud rate fixed at 115,200 bits per second
- The baud rate can be changed in the Setup. See “Baud Rate Setup” on page 11.

## Wired IR Input

The IR Input allows an external IR receiver to be attached to the MCD85. The Input is labeled IR IN. By attaching an IR receiver using a 3.5mm cable (see Figure 08), the MCD85’s Remote Control can be used in another location without a line-of-sight to the MCD85’s front IR sensor.

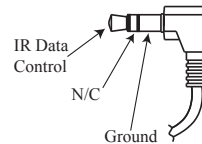

Figure 08– IR 3.5mm connector

If using an external IR receiver for the MAIN ZONE in the same room as the MCD85, you may wish to **disable the front IR sensor**. This will avoid potential timing issues of receiving the Remote Control’s commands from two different Inputs. The front IR can be turned on/off by doing the following:

- Press and Hold the Left Knob for two seconds
- Turn the Left Knob to the menu choice “SETUP: Front IR”
- Turn the Right Knob clockwise for Enabled (on) or counterclockwise (off)

- Press and release the Left Knob to exit the Setup menu

## AC Power

This connection is essential. Plug the female end of the supplied AC Power Cord into the AC connector (standard 15 ampere IEC) located in the rear right corner of the MCD85. Plug the male end of the AC Power Cord into a grounded and functioning AC outlet.

## Power Control (Trigger) Output

The MCD85 has two Power Control jacks or Triggers. One is an input (IN) and the other is an output (OUT).

Power Control enables power on/off signals to go to connected components so that other components can automatically powered on (or off).

The controlling unit should be connected to the IN jack. The MCD85 and units connected to the OUT jack will follow the power status of the controlling unit.

Connect components to the Triggers using a 3.5mm stereo mini plug. See Figure 09. The Triggers work by sending on/off signals in the form of +12 volt/0 volt to connected McIntosh components.

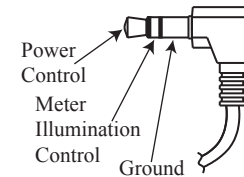

Figure 09– Power control (trigger) mini plug

continued on page 9



## Connection Diagram

Here are some common connections for the MCD85:

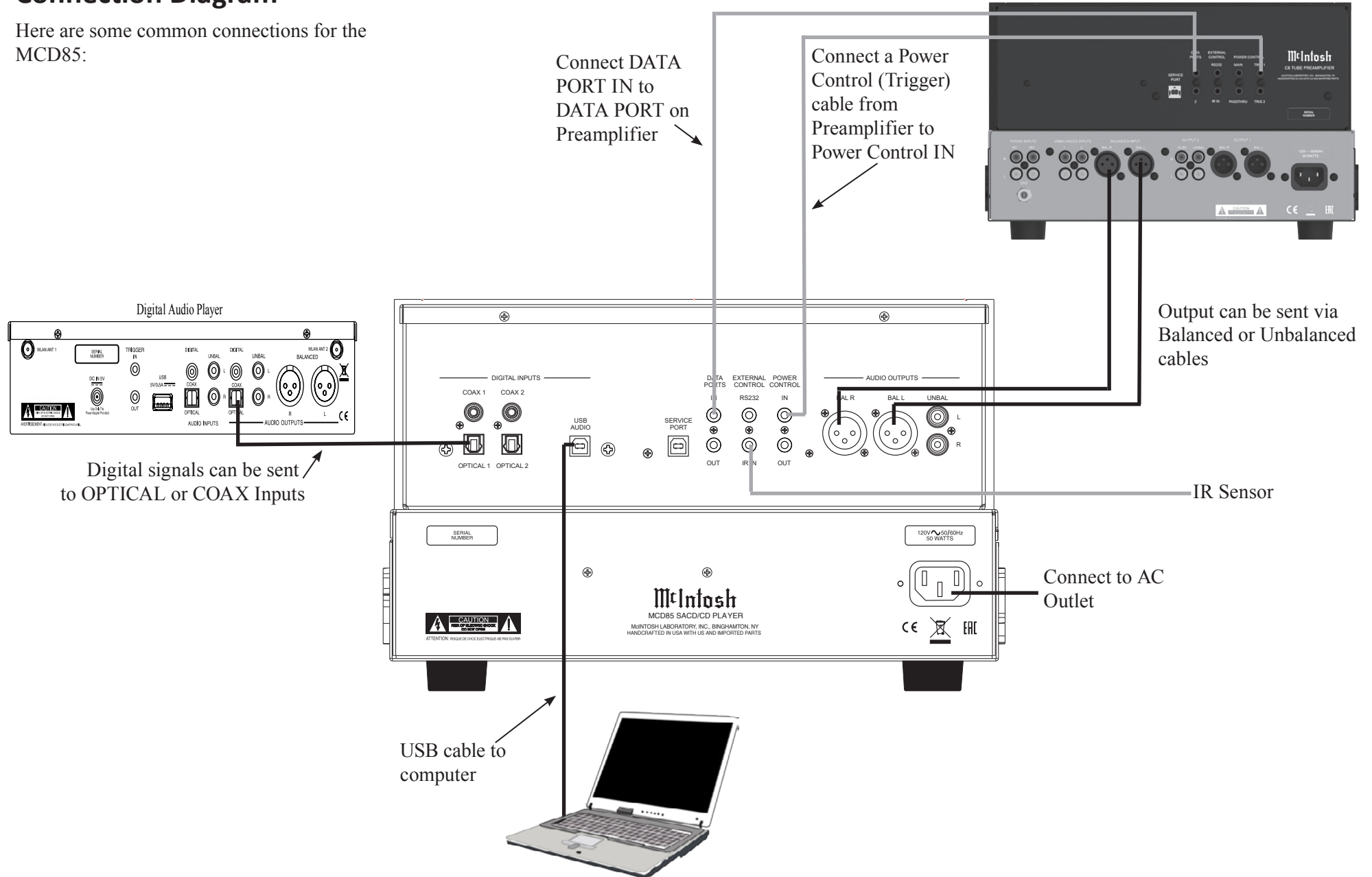



## Data Ports

The IN DATA PORT allows a connected McIntosh component to send basic converted IR commands to control the MCD85 even from another room. The OUT DATA PORT will send the converted IR commands to another attached McIntosh component.

To connect a McIntosh unit to a Data Port, use a 3.5mm stereo mini phone plug cable, Figure 10.

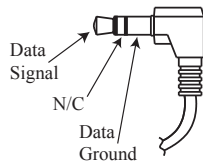

Figure 10– Data Port mini plug

## USB Audio

The USB AUDIO input of the MCD85 provides the capability to receive music/sound in a digital format from a connected computer.

### Software Requirements

Apple® Macintosh® computers require OS-10.6.8 or later. Apple computers require no additional driver install to communicate with the MCD85.

For Windows-based computers (PC), Windows 7 (SP1) or later is required. The correct McIntosh USB Audio driver must be installed for the PC to communicate with the MCD85.

To **install the McIntosh USB Driver** for Windows-based computers:

Download the latest driver from the McIntosh website: <https://www.mcintoshlabs.com/products/integrated-amplifiers/MCD85>

The driver can be found in the Downloads section of the webpage under Software Updates. Choose the DA1 Digital Audio Module: McIntosh USB Audio Windows Driver.

- Unzip the McIntosh\_UsbAudio file
- Run the File
- Choose “Yes” to allow changes to your computer (See Figure 11)
- Follow software prompts selecting “Next” or “Install” as needed
- Click “Finish” when driver is installed

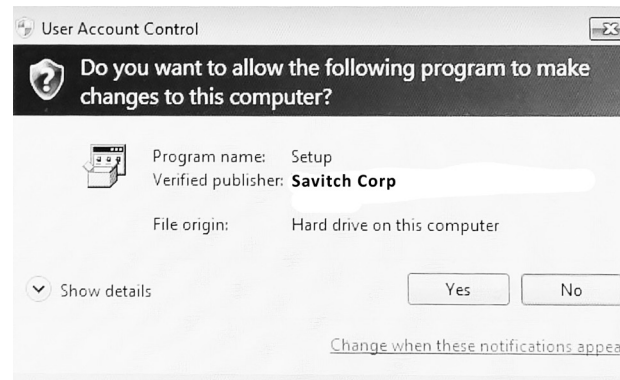

Figure 11– Installing USB Driver Software

Next, connect the Computer to the MCD85 using a **USB 2.0** Cable Type A to Type B (see Figure 12) Windows should detect the new device (if you installed the driver software as directed above) and



Figure 12– USB cable

install the driver as indicated by a message in the lower part of your monitor.

You can use the Windows Control Panel to select the new audio device which will appear as “McIntosh HD-HS USB Audio”. You may also select this driver in many third-party applications such as JRiver Media Center.

The MCD85’s display will show the sampling rate or bit rate for the USB input.

## USB Service Port

The USB SERVICE PORT on the rear of the MCD85 is for McIntosh service use only. Use the USB AUDIO port for audio input.

## Optical

The two Optical Inputs allow digital sources to be connected to the MCD85 using TOSLINK cables also known as “optical audio cables.” The Optical Inputs can handle high resolution digital audio up to 192kHz/24-bit. The MCD85 DAC will process standard format SPDIF PCM signals. Unsupported formats can result in strange and/or unpleasant sounds.

## Coax

The two Digital Coax (Coaxial) Inputs allow digital sources to be connected to the MCD85 using Digital Audio RCA Coaxial Cables. The Coax Inputs can handle high resolution digital audio up to 192kHz/24-bit. The MCD85 DAC will process standard format SPDIF PCM signals. Remember, unsupported formats can result in strange and/or unpleasant sounds.



## Power On the MCD85

To power on the MCD85, press and release the Right Knob. To power the MCD85 off, do this again.

## Setup Menu

**To enter the Setup Menu, push and release the Left Knob.** Turning the Left Knob will scroll through the available options.

Setting	Options
MCD85	Displays current firmware version
S/N AJGxxxx	Displays the serial number of the MCD85
DA FW Vx.x	Displays the current firmware for the digital adapter
Auto-Off	ON (default) / OFF
AutoMute	ON (default) / OFF
IR Code	Norm (default) / Alt
Front IR	ON (default) / OFF
Power IR	ON (default) / OFF
IR Input	ON (default) / OFF
DATA	All (default), COAX 1, COAX 2, OPT 1, OPT 2
Inputs (HOLD) <i>Hold Left Knob to enter submenu</i>	<b>Submenu Choices:</b> CD PLAYER, COAX 1, COAX 2, OPT 1, OPT 2, USB <b>Options for each:</b> ON (default) / OFF
BAUD	115200 (default), 9600, 19200, 38400, 57600

## Firmware Version

Firmware is internal software that controls the MCD85's functionality.

The version of the main firmware of the MCD85 can be viewed by entering the Setup Menu. Enter this by pressing and releasing the Left Knob. The first setting is called MCD85. The number to the right is the version number. For example, if the VFD displays "MCD85 V1.01", then the main firmware is version 1.01.

There is also firmware for controlling the digital audio hardware. To see the Digital Audio (DA) firmware version, enter the Setup Menu. Rotate the Left Knob until you see "DA FW". The number following the V to the right is the Digital Audio firmware version.

Firmware upgrades when available can be installed by qualified technicians.

## Serial Number

The MCD85's unique serial number can be viewed by entering the Setup Menu and rotating the Left Knob until you see "S/N:". The number (and letters) to the Right are the unit's serial number. This number can also be found on the rear of the unit.

## Auto-Off

Auto-Off can be toggled On (default) or Off. Enter the Setup Menu. Select On or Off by rotating the Right Knob.

When the Auto-Off feature is enabled, the MCD85 will power off when no audio input or user interaction has been detected for approximately 30 minutes.

## AutoMute

The Automute Feature helps to ensure noise free playback of streaming music via the USB Input. With AutoMute enabled, the MCD85 will employ a brief mute as the Digital Audio Signal format changes (PCM, DSD, etc.). Occasionally, because of the particular way a recording was produced, it may be desirable to switch Off the Automute Feature. This will eliminate the brief gap between different formats.

To toggle AutoMute On or Off, enter the Setup Menu. Select On or Off by rotating the Right Knob.

## IR Code

The IR Code setting allows you to select an alternative set of remote control codes to use for the remote control of the MCD85. The default is to use the Normal control codes which will be perfectly fine for the vast majority of situations. If you have another unit being controlled with the same control codes, conflicts can arise. If this is the case, change IR Code setting to "Alt". The remote control for the MCD85 must also be set to use the alternate codes.

To set the MCD85's remote control to use alternate (Alt) codes, press and hold the SELECT button and press the "2" button. Hold until the two LEDs to the right of the SHIFT button flash twice.

To set the MCD85's remote control to use normal codes, press and hold the SELECT button and press the "1" button. Hold until the two LEDs to the right of the SHIFT button flash twice.

## Front IR

Front Panel Sensor, which receives the signals from the Remote Control, can be switched off to prevent interference when an external IR Sensor

is connected. To de-activate the Front IR, enter the Setup Menu. Select On or Off by rotating the Right Knob.

## Power IR and IR Input

The MCD85 can be controlled by another McIntosh unit's remote control using the DATA IN PORT. This is convenient for using commands on the other remote such as PLAY or NEXT, but it is possible that you may not want Power commands or Input commands sent by the connected unit to control the MCD85.

If you wish to disable Power Commands coming from the DATA PORT or from a connected external IR sensor connected the IR IN, enter the Setup Menu. Select On or Off by rotating the Right Knob. If you wish to disable Input Commands coming from the DATA PORT or from a connected external IR sensor connected the IR IN, enter the Setup Menu. Select On or Off by rotating the Right Knob.

## Data Setup

Data Port connections allow the Remote Control commands sent to the MCD85 to be sent to components attached via the Data Ports. Data Setup defines when to send that data based on the selected Input. The default is "All" which will send data to a connected component whenever data is received. The options for when to send data are:

- All (Default)
- Coax 1
- Coax 2
- Opt 1
- Opt 2

To select when Data will be send a component connected to the DATA OUT PORT, enter the Setup Menu. Rotate the Right Knob to select one of the

available options.

## Input Setup

You have the ability to control which inputs appear on the display when you rotate the Input (Right) Knob. If you wish to remove an unused input or restore a previously removed input:

- Push and release the Left Knob to enter Setup
- Rotate the Left Knob until the VFD displays "Inputs (Hold)"
- Press and Hold the Left Knob for two seconds. "CD PLAYER" will appear in the VFD
- Rotate the Left Knob to select the input you wish to display or hide
- Rotate the Right Knob to select On or Off
- Press and release the Left Knob twice to exit the Setup Menu

## Baud Rate Setup

The MCD85 can be controlled remotely via the RS232 Jack. The settings for serial communications are:

8 bit, No parity and 1 stop bit

The speed can be adjusted from the Setup Menu.

To adjust the BAUD rate, enter the Setup Menu. Rotate the Left Knob until you reach "BAUD: ...". Rotate the Right Knob to select from the following options:

9600, 19200, 38400, 57600, and 115200 (default).

## FACTORY RESET

Use the FACTORY RESET option if you wish to return all settings to factory defaults. All previous setup changes will be lost.

To Factory reset the MCD85, enter the Setup Menu.

Rotate the Left Knob until "FACTORY RESET" appears on the display. Hold the Left Knob down until "In Progress" appears on the screen. When the Factory reset is complete, the MCD85 will power off.

## Play a Disc

- Rotate the Right Knob (INPUT) until CD PLAYER appears on the Display
- Press and release the OPEN/CLOSE button to open the tray
- Place the disc, label side up, on the tray
- Press and release the OPEN/CLOSE button to close the tray
- "Reading" will appear on the Display followed by Disc information
- You may rotate the Left Knob (BACK NEXT) to pick a particular track
- Press and release the PLAY/PAUSE button to Play; press again to Pause

Additional commands are available on the Remote Control. See "Remote Control Buttons" on page 13.

The **Program Playback** feature allows the playback of selected tracks in a chosen order. To use this feature, Press the SHIFT button on the Remote Control and then press the RANDOM button twice. Use the numeric buttons to enter the desired tracks. Press the Play ► button to begin playing the programmed tracks.

## Navigating CD-ROMs

The Remote Control buttons 2, 4, 6 and 8 can be used for navigating up, down, left, right through tracks/folders on a CD-ROM. The 5 button can be used to Enter the folder or Play the track shown on the Display.



## Vacuum Fluorescent Display (VFD)

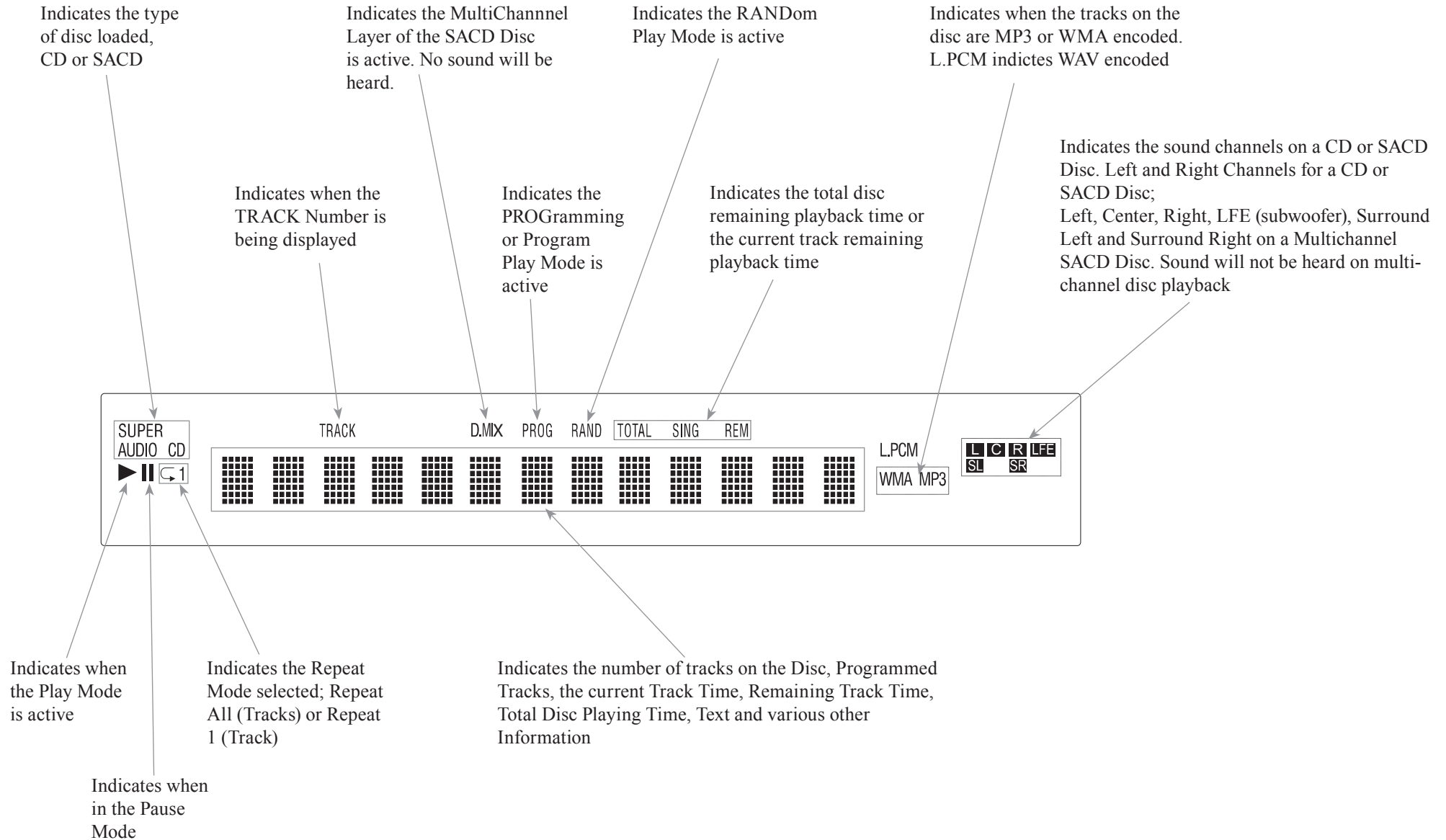

## Remote Control Buttons

SHIFT push-button with LED Indicators used to select a push-button function with white or gold color nomenclature

Use to CLEAR the last programmed track

Access the TEXT Display Mode when playing a SACD Disc containing the information

Use to select various disc information, including TIME, on the Front Panel DISPLAY. It is also used to cancel the text display mode on a SACD Disc

Use to select the SACD or CD Tracks from a hybrid disc for playback

Press to play the Previous Selection. Also used to select one of various REPEAT modes

Press once to PLAY, a second time to PAUSE and a third time to RESUME playback. Also used to activate RANDOM playback of the tracks on a SACD or CD disc

Press to FAST-REVERSE thru the current selection

Momentarily press to Power ON or OFF

Use to select disc tracks or any numbered operation

Use to direct access tracks 10 and above

Selects the All MODE or the Folder MODE for navigating and selection of music on a CD-R or DVD ±R and Flash Drive

LEVEL Control adjusts the volume level for the Rear Panel Variable Audio Output Connectors and the Front Panel Headphone Jack

Press to play the next Selection

Press to FAST-FORWARD thru the current selection

Select Disc, USB Mode or Coax/Optical Digital Inputs

Press to STOP disc playback

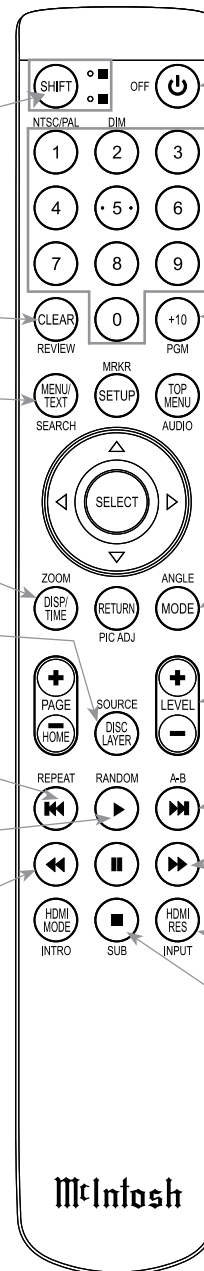

*Note: The Remote Control Push-buttons not identified are for use with other McIntosh Products*



## Changing the Remote Control's Battery

Someday, the two AAA battery in the Remote Control will need to be replaced. To replace the two AAA batteries:

- Locate the battery door. Looking at the back of the remote, the battery door is in the lower part
- Slide battery door towards the bottom of the Remote Control. The battery door will slide open 1/4 inch (0.63cm)
- Lift the door up to reveal the batteries
- Remove the old batteries
- Insert two new AAA batteries noting the polarity which is printed on the bottom of the battery compartment. The spring will connect with the negative (-) part of the battery
- Place the door over the batteries leaving a 1/4 inch gap
- Slide the door up towards the top of the remote to secure

## Specifications

### Disc Media

CD, SACD, DVD (data)

### Fixed Output level

2.0Vrms Unbalanced

4.0Vrms Balanced

### Output Impedance

100 ohms Unbalanced and Balanced

### Signal to Noise Ratio

Better than 98dB (A-weighted)

### Harmonic Distortion

0.02% @ 1000Hz

### Frequency Response

±0.5dB from 20Hz-20,000Hz

### Playable Disc Media Files

Format	Up To Frequency/ Bit	Bit Rate
MP3 (.mp3)	48KHz	up to 320kbps
WMA (.wma)	48KHz	up to 320kbps
AAC (.aac/ mp4)	48KHz	up to 320kbps
WAV (.wav)	192KHz/24 Bit*	uncompressed
FLAC (.flac)	192KHz/24 Bit*	uncompressed
ALAC (.m4a)	96KHz/24 Bit*	uncompressed
AIFF (.aif/aiff)	192KHz/24 Bit*	uncompressed
DSD (.dff/dsf)	DSD128 (5.6MHz)	uncompressed

\*up to 48KHz with CD-R/+RW

### Power Control and Trigger Output

12VDC, 25mA

### Power Requirements

*Field AC Voltage conversion of the MCD85 is not possible. The MCD85 is factory configured for one of the following AC Voltages:*

100 Volts, 50/60Hz at 35 watts

110 Volts, 50/60Hz at 35 watts

120 Volts, 50/60Hz at 35 watts

220 Volts, 50/60Hz at 35 watts

230 Volts, 50/60Hz at 35 watts

240 Volts, 50/60Hz at 35 watts

Standby, less than 0.5 watt

*Note: Refer to the rear panel of the MCD85 for the correct voltage.*

### Overall Dimensions

Width is 12-5/32 inches (31.2 cm)

Height is 7-3/4 inches (19.7cm) including feet

Depth is 16-1/4 inches (41.3cm) including the Front Panel, Knobs and Cables

### Weight

20.5 pounds (9.3Kg) net, 27.5 pounds (12.5Kg) in shipping carton

### Shipping Carton Dimensions

Width is 20-3/8 inches (51.8cm)

Height is 13-1/4 inches (33.7cm)

Depth is 16-1/4 inches (41.3cm)

## Resetting the Microprocessor

In the unlikely even the MCD85 stops functioning properly and the Factory Reset procedure (see “FACTORY RESET” on page 11) does not solve the issue, you can try the following procedure to reset the secondary (transport) microprocessor:

- Power off the MCD85
- Remove the AC power cord from the rear of the MCD85
- Wait a few seconds for the standby LED to turn off
- Push and Hold the Left Knob in while pressing and holding the STOP button
- Plug the AC power cord into the rear of the MCD85
- When “INITIALIZED” appears on the Display, release the Left Knob and STOP button

The MCD85 should be reset in a few more seconds.

## Packing the MCD85

When shipping the MCD85, it is highly recommended that the unit be packed as it was originally shipped to avoid damage. Failure to properly pack the unit will likely result in damage. (The front panel is made of glass!) If you need any of the packing material, you can contact McIntosh Customer Service. Use only packing material that is in good condition and replace any material that has seen better days.

It is very important that the four plastic feet are properly placed in the holes of the Foam Bottom Pad. This will ensure the proper equipment location for shipping. Failure to do this will result in shipping damage.

Quantity	Part Number	Description
1	034661	Shipping Carton
1	034654	Foam Pad Bottom
1	034658	Foam Top Cover
1	034656	Foam Ring
1	034657	Foam Upper Ring
1	034655	Foam Top
1	034662	Sheet Slit Scored

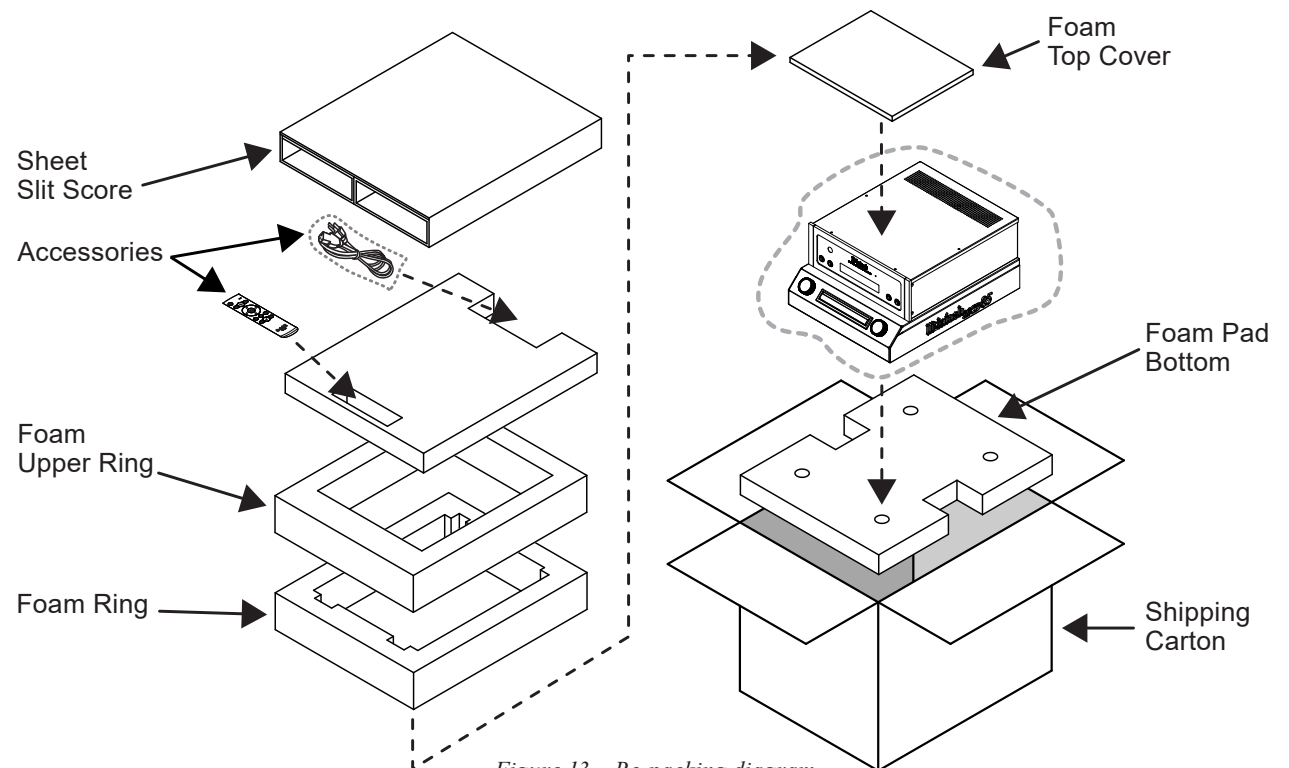

Figure 13- Re-packing diagram



The continuous improvement of its products is the policy of McIntosh Laboratory Incorporated who reserve the right to improve design without notice.

Printed in the U.S.A.

McIntosh Part No. 24110300